

Sept 6, 2018 |

GARRETT INVESTOR CONFERENCE – NYSE: GTX

New York City

Garrett
ADVANCING MOTION

ADDITIONAL INFORMATION

For additional information with respect to Garrett and the proposed spin-off, please refer to the Form 10 Registration Statement, as it may be further amended, on file with the Securities and Exchange Commission. The spin-off is subject to customary conditions, including final approval by Honeywell's board of directors. The financial information included in this document may not necessarily reflect Garrett's financial position, results of operations, and cash flows in the future or what Garrett's financial position, results of operations, and cash flows would have been had Garrett been an independent, publicly traded company during the periods presented. This communication shall not constitute an offer of any securities for sale, nor shall there be any offer, sale or distribution of securities in any jurisdiction in which such offer, sale or distribution would be unlawful prior to appropriate registration or qualification under the securities laws of such jurisdiction.

FORWARD LOOKING STATEMENTS

This presentation contains "forward-looking statements" within the meaning of Section 21E of the Securities Exchange Act of 1934. All statements, other than statements of fact, that address activities, events or developments that we or our management intend, expect, project, believe or anticipate will or may occur in the future are forward looking statements. Although we believe forward-looking statements are based upon reasonable assumptions, such statements involve known and unknown risks, uncertainties, and other factors, which may cause the actual results or performance of the company to be materially different from any future results or performance expressed or implied by such forward-looking statements. Such risks and uncertainties include, but are not limited to those described in our Registration Statement on Form 10 under the headings "Risk Factors" and "Cautionary Statement Concerning Forward-Looking Statements." You are cautioned not to place undue reliance on these forward-looking statements, which speak only as of the date of this document. Forward looking statements are not guarantees of future performance, and actual results, developments and business decisions may differ from those envisaged by our forward-looking statements.

NON-GAAP FINANCIAL MEASURES

This presentation includes Consolidated EBITDA, Consolidated EBITDA Margin, Adjusted EBITDA and Adjusted EBITDA Margin figures that are not compliant with generally accepted accounting principles in the United States ("GAAP"). The Non-GAAP financial measures provided herein are consolidated for certain items as presented in the Non-GAAP Reconciliations and may not be directly comparable to similar measures used by other companies in our industry, as other companies may define such measures differently. Consolidated EBITDA is defined in accordance with our proposed Credit Agreement and differs from EBITDA as presented herein. Management believes that, when considered together with reported amounts, these measures are useful to investors and management in understanding our ongoing operations and in analysis of ongoing operating trends. In addition, Consolidated EBITDA is used as part of our calculations with respect to compliance with certain debt covenants included in our proposed credit agreement. Garrett believes that Consolidated EBITDA, Consolidated EBITDA Margin, Adjusted EBITDA and Adjusted EBITDA Margin are important indicators of operating performance because they exclude the effects of income taxes and certain other expenses, as well as the effects of financing and investing activities by eliminating the effects of interest and depreciation expenses and therefore more closely measures our operational performance. These metrics should be considered in addition to, and not as replacements for, the most comparable GAAP measure. Refer to the Appendix attached to this presentation for reconciliations of Non-GAAP financial measures to the most directly comparable GAAP measures. For additional information with respect to our Unaudited Combined Financial Statements, see our Form 10.

Investor conference agenda

| | | |
|---------------|-------------------------------------|---|
| 8:30 - 8:40 | Welcome and Introduction | Paul Blalock, VP - IR |
| 8:40 - 9:30 | Executive Overview | Olivier Rabiller, CEO |
| 9:30 - 10:00 | Technology Overview | Craig Balis, CTO |
| 10:00 - 10:15 | Break | |
| 10:15 - 10:30 | Operational Overview | Thierry Mabru, SVP - Integrated Supply Chain |
| 10:30 - 11:15 | Financial Overview | Alessandro Gili, CFO |
| 11:15 - 11:30 | Conclusion and Key Takeaways | Olivier Rabiller |
| 11:30 - 12:30 | Q&A with Management Team | |
| 12:30 - 12:45 | Light Lunch | |
| 12:45 - 2:00 | Technology Demonstrations | |



Turbo Technology













Electric & Hybrid



Connected Vehicles

Today's presenters

| NAME | YEARS IN INDUSTRY | SELECTED EXPERIENCE | PREVIOUS EXPERIENCE |
|--|-------------------|--|---|
|  <p>Olivier Rabiller <i>CEO</i></p> | 23 | <ul style="list-style-type: none"> • Named President and CEO of Garrett in July 2016; joined in 2002 • Previously served at Renault in Customer Services, Engine Project Management and Purchasing |  <small>THE POWER OF CONNECTED</small>  |
|  <p>Craig Balis <i>CTO</i></p> | 20 | <ul style="list-style-type: none"> • Named VP and Chief Technology Officer in August 2014 • Previously served in Turbine Engine Engineering in Honeywell Aerospace |  <small>THE POWER OF CONNECTED</small> |
|  <p>Thierry Mabru <i>SVP Integrated Supply Chain</i></p> | 26 | <ul style="list-style-type: none"> • Named VP Global Integrated Supply Chain in February 2013 • Previously served as a Director and a Business Leader in Honeywell Aerospace |  <small>THE POWER OF CONNECTED</small> |
|  <p>Alessandro Gili <i>CFO</i></p> | 18 | <ul style="list-style-type: none"> • Named CFO of Garrett in May 2018 • Previously CFO of Ferrari, including IPO and spinoff from FCA in 2015-2016 |   |

Executive Overview

Olivier Rabiller - CEO



Garrett is a cutting-edge technology provider that enables vehicles to become safer, more connected, efficient and environmentally friendly.

We lead the development of innovative and differentiated solutions which empower the transportation industry to redefine and further advance motion.

Garrett at a glance



¹ Consolidated EBITDA is a Non-GAAP financial measure; please refer to the Appendix for its definition and a reconciliation to Net Income and Adjusted EBITDA as presented in the Form 10

² Excludes Honeywell Indemnity Obligation payment; ³ Please refer to the Appendix for organic growth rates reconciled to the comparable GAAP financial measure

⁴ Constant currency, excluding Honeywell Indemnity Obligation payment and FX impact

Key investment highlights

1. Global market leadership with accelerating macro tailwinds
2. Technology leadership and broad portfolio of products with breakthrough capabilities
3. Long-term co-development with global OEMs and a worldwide aftermarket platform
4. Best-in-class global manufacturing footprint with operational excellence and agility
5. Attractive financial profile



Turbo Technology



Electric & Hybrid



Connected Vehicles

1

Global market leadership with accelerating macro tailwinds

A differentiated global leader

Net revenue

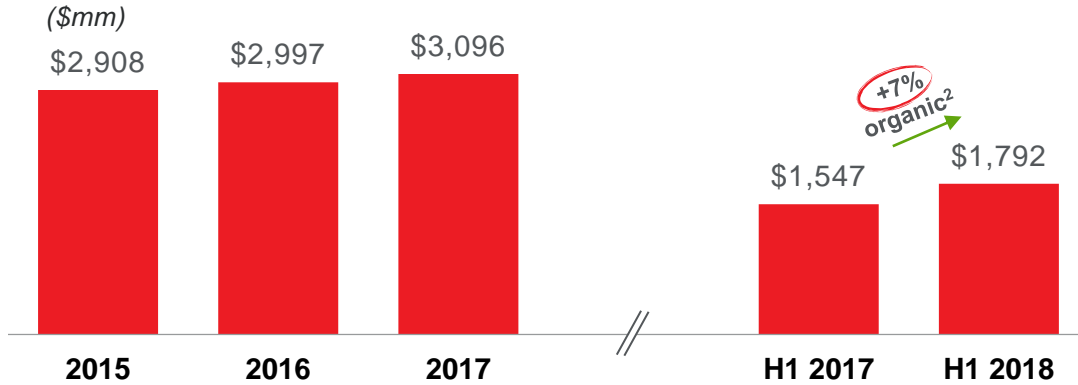

Consolidated EBITDA¹

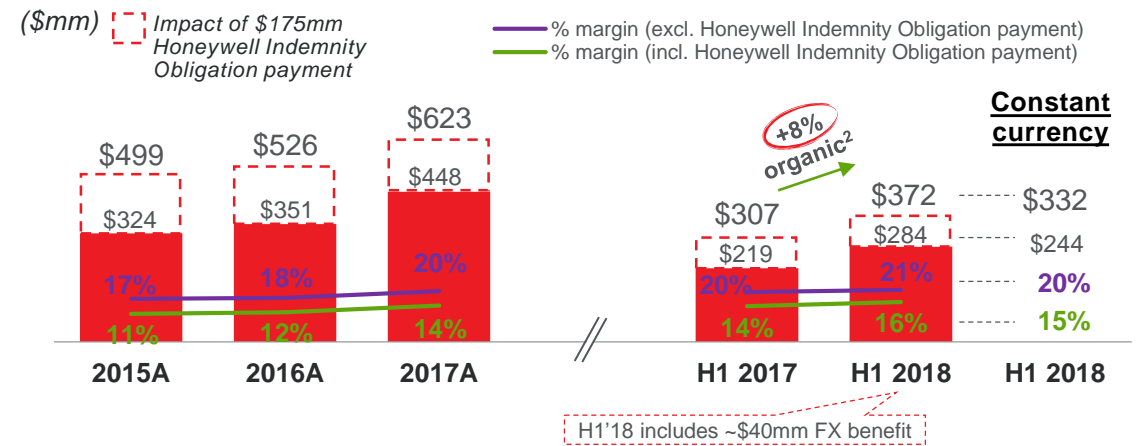

Revenue by Geography

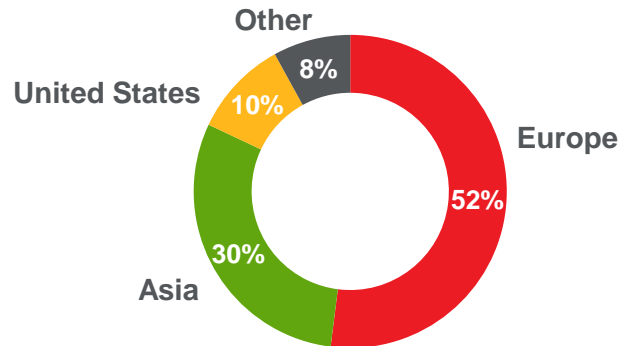

Revenue by Product Line

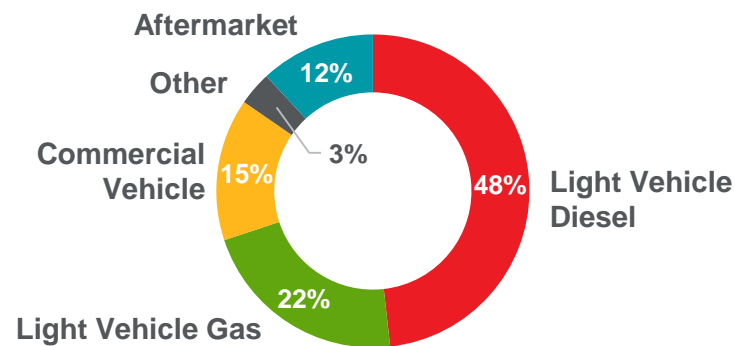

Revenue by Customer

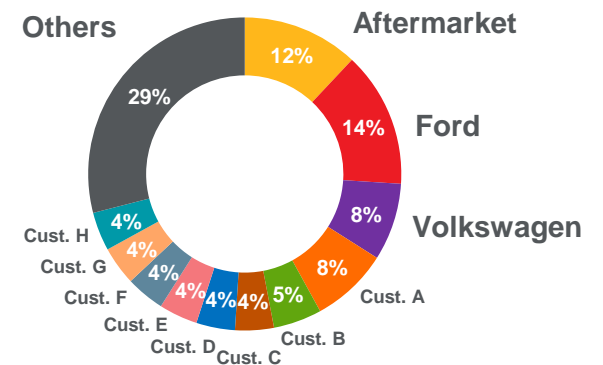

Note: Revenue breakdowns based on 12/31/2017 financial data

¹ Consolidated EBITDA is a Non-GAAP financial measure; please refer to the Appendix for its definition and a reconciliation to Net Income and Adjusted EBITDA as presented in the Form 10

² Constant currency, excluding FX impact

Copyrights © 2018 Garrett Motion Inc.

1

Global market leadership with accelerating macro tailwinds

Accelerating macro tailwinds fuel strong outlook

Tougher Global CO₂ Regulations

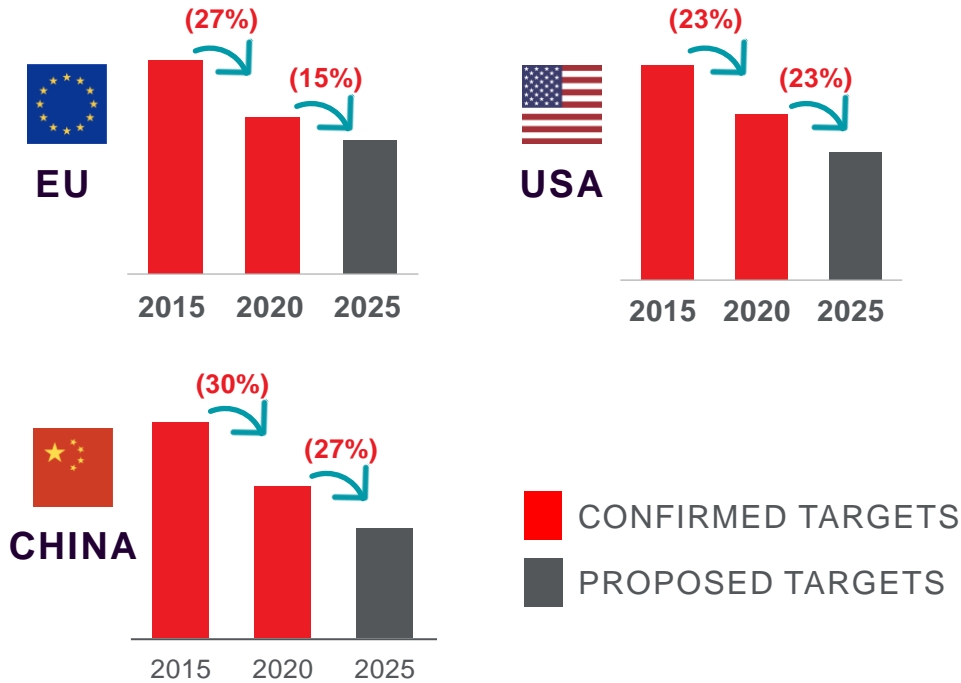

Source: Government reports

Turbo Penetration Outlook

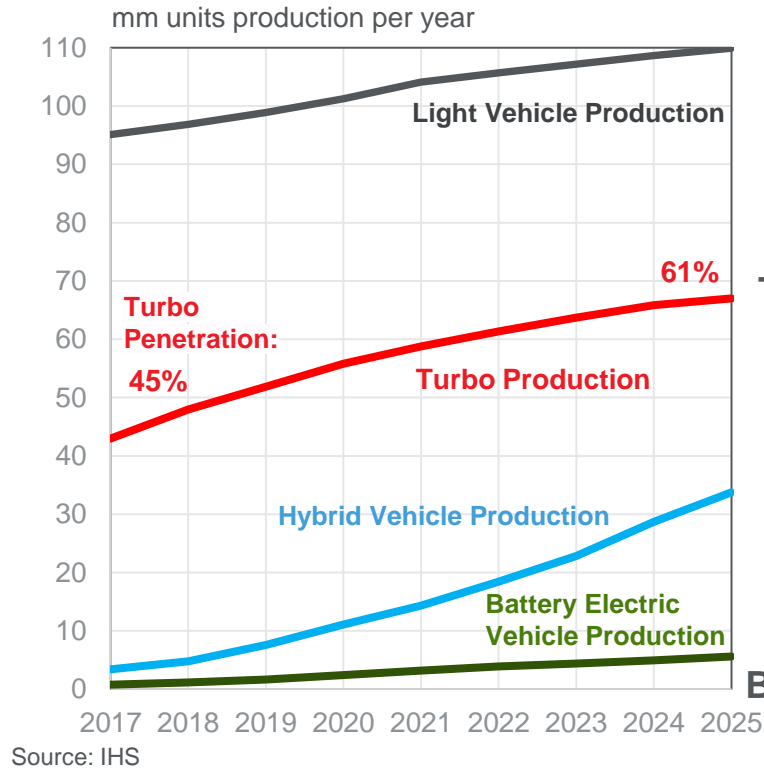

- + 15mm**
New cars by 2025
1-2% CAGR 2017-2025
- + 24mm**
Turbocharged cars by 2025
5% CAGR 2017-2025
- + 30mm**
Hybrid cars by 2025
30% CAGR 2017-2025
- + 5mm**
Battery Electric cars by 2025
30% CAGR 2017-2025

- Converging global regulations driving higher turbo utilization and growth
- Explosive growth in turbo penetration for hybrids from 17% in 2017 to 76% by 2025

1

Global market leadership with accelerating macro tailwinds

Dynamic Market: Turbo adoption in all regions

Turbocharger Production and Penetration by Region

NORTH AMERICA
7.0mm → 9.3mm turbos

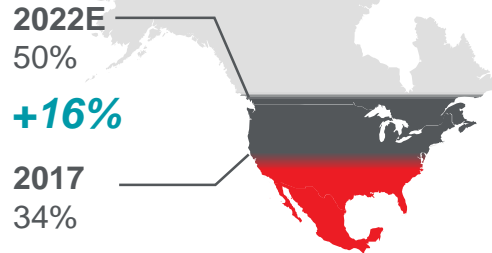

EUROPE
18.4mm → 19.3mm turbos

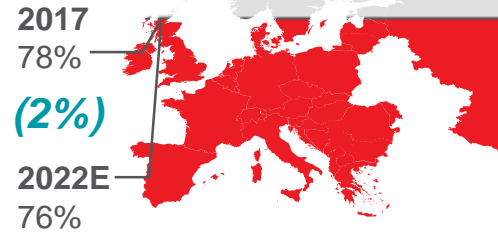

INDIA
2.5mm → 3.7mm turbos



SOUTH AMERICA
0.7mm → 2.4mm turbos

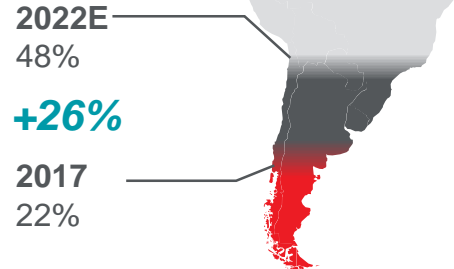

CHINA
14.5mm → 24.7mm turbos



JAPAN
2.3mm → 3.1mm turbos

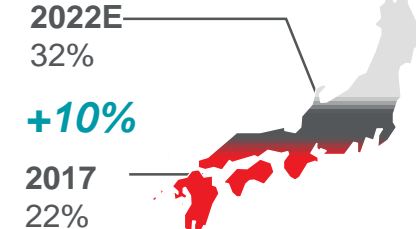

Note: Geographic breakdown represents vehicle production based on IHS, KGP, and PSR data

1

Global market leadership with accelerating macro tailwinds

Dynamic Market: Well-positioned in attractive channels



Go-to-market Verticals

| CHANNEL | | % OF REVENUE ¹ | MARKET GROWTH | PLATFORM EXAMPLES | KEY TAKEAWAYS |
|---------|------------------------|---------------------------|---------------|---|---|
| CORE | LIGHT VEHICLE DIESEL | 48% | | BMW X5 | <ul style="list-style-type: none"> Market leader with favorable platform mix Well positioned in strongest market segments |
| | LIGHT VEHICLE GASOLINE | 22% | | Ford Mustang | <ul style="list-style-type: none"> Rapidly growing share and scale Leading Variable Nozzle Turbine (VNT) technology |
| | COMMERCIAL VEHICLE | 15% | | JCB DieselMax | <ul style="list-style-type: none"> Long history of innovation in the market Consistent leader with technology advantages |
| | AFTERMARKET | 12% | | Garrett G25 | <ul style="list-style-type: none"> Stable aftermarket business with strong brand equity Extensive and global distribution network |
| GROWTH | E-BOOSTING | 3% | | Honda Clarity | <ul style="list-style-type: none"> High growth opportunity with E-Compressor and E-Turbo Play in hydrogen fuel cell vehicles |
| | CONNECTED VEHICLE | <1% | | Cyber Security Integrated Vehicle Health Management | <ul style="list-style-type: none"> Well positioned to play in key areas of the future Focused on areas with “right-to-play” |

¹ Represents 2017 financials

1

Global market leadership with accelerating macro tailwinds

Diesel is a key powertrain technology for larger vehicles



Diesel dynamic

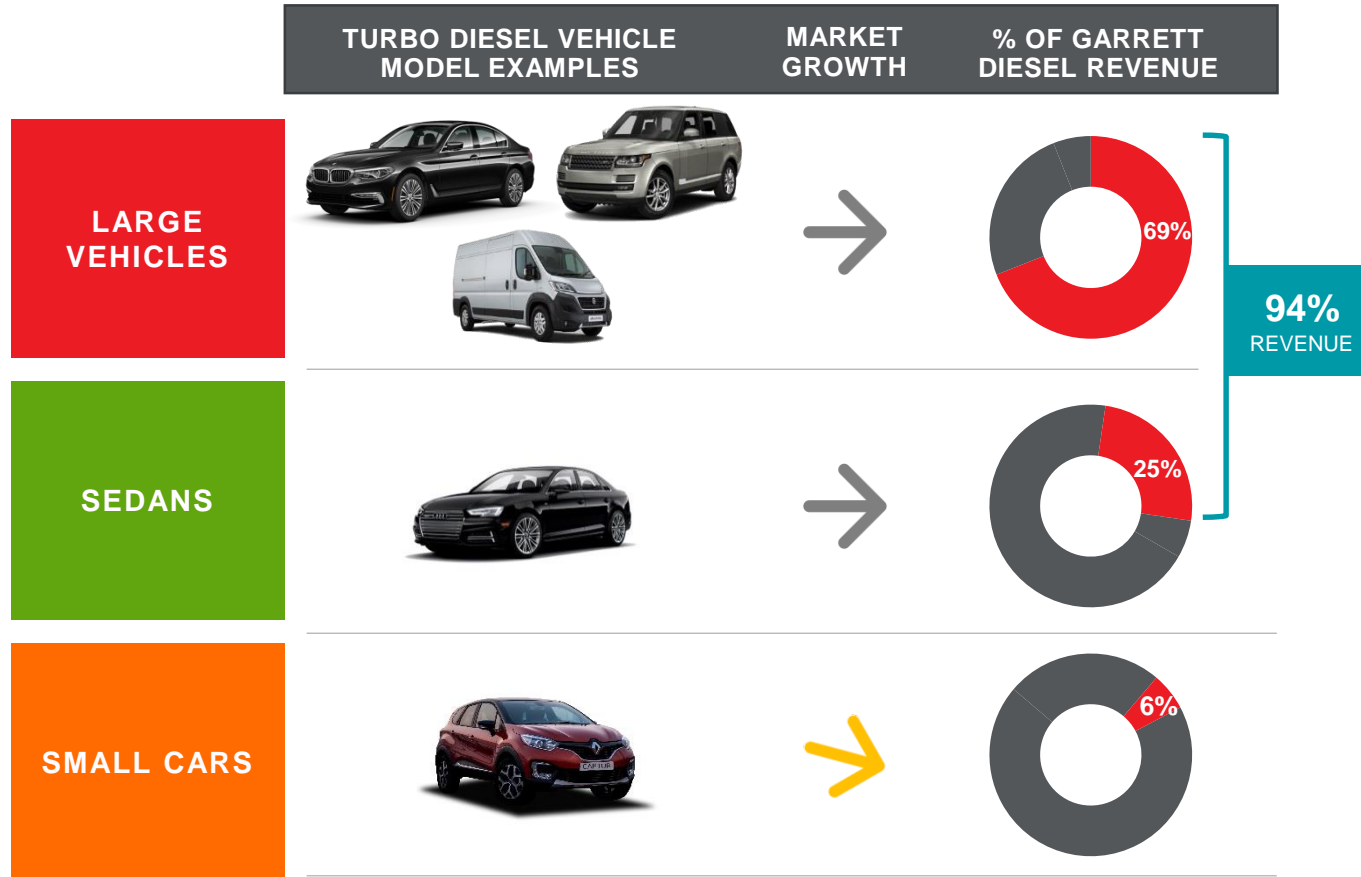

Diesel benefits

- Fuel economy improvement by up to 20% in larger vehicles
- 10-15% less CO₂ than gasoline equivalent
- Higher torque for heavier vehicles and increased towing capacity

Garrett advantages

- Limited exposure to small cars
- Emission requirements driving higher technology content
- Large opportunity for hybrids

2

Technology leadership and broad portfolio of products with breakthrough capabilities

Technology: A long history of innovation

Milestones

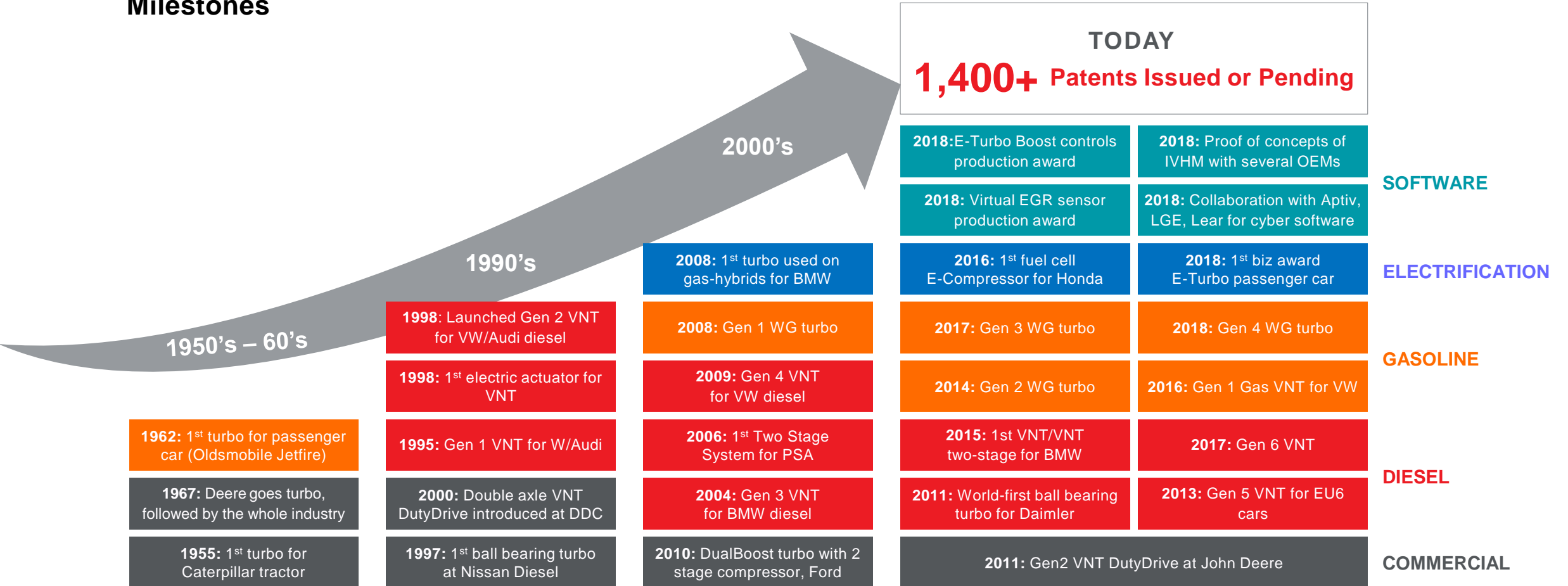

Note: WG – Wastegate turbine (fixed geometry); VNT – Variable Nozzle Turbine; EVR – Exhaust gas recirculation; IVHM – Integrated Vehicle Health Management

Copyrights © 2018 Garrett Motion Inc.

Technology: Strategic roadmap

CORE TURBO

Continuous differentiated innovation

- 60+ years of technology leadership and product innovation
- Highly-engineered products deeply integrated with customers
- Broadest portfolio across vehicle segments

ELECTRIFICATION & SOFTWARE

Next generation of technology leadership

- Extending strong turbo foundation into electric boosting
- Expanding portfolio for electrified vehicles
- Differentiated software solutions for connected vehicles

PIPELINE

Advanced technology for new unmet customer needs

- Novel solutions for electrified, connected and autonomous vehicles
- Building on our strong customer intimacy and collaboration

2

Technology leadership and broad portfolio of products with breakthrough capabilities

Global scale and broad product portfolio



| | MANUFACTURER | LIGHT VEHICLE GAS | LIGHT VEHICLE DIESEL | COMMERCIAL VEHICLE | E-BOOSTING |
|----------------------------|---|-------------------|----------------------|--------------------|------------|
| MAJOR GLOBAL PLAYERS | Garrett ADVANCING MOTION | ● | ● | ● | ● |
| | BorgWarner Turbo Systems | ● | ● | ● | ● |
| MEDIUM SIZE GLOBAL PLAYERS | IHI Turbochargers | ● | ● | ● | ● |
| | MITSUBISHI | ● | ● | ● | ● |
| | BOSCH MAHLE | ● | ● | - | - |
| | Continental | ● | - | - | ● |
| | Cummins Turbo Technologies | - | - | ● | ● |
| LOCAL PLAYERS | VÖFON WEIFU TYEN HYUNDAI WIA | ● | ● | ● | - |

● LEADER ● PARTICIPANT

Copyrights © 2018 Garrett Motion Inc.

2

Technology leadership and broad portfolio of products with breakthrough capabilities

Comprehensive technology portfolio

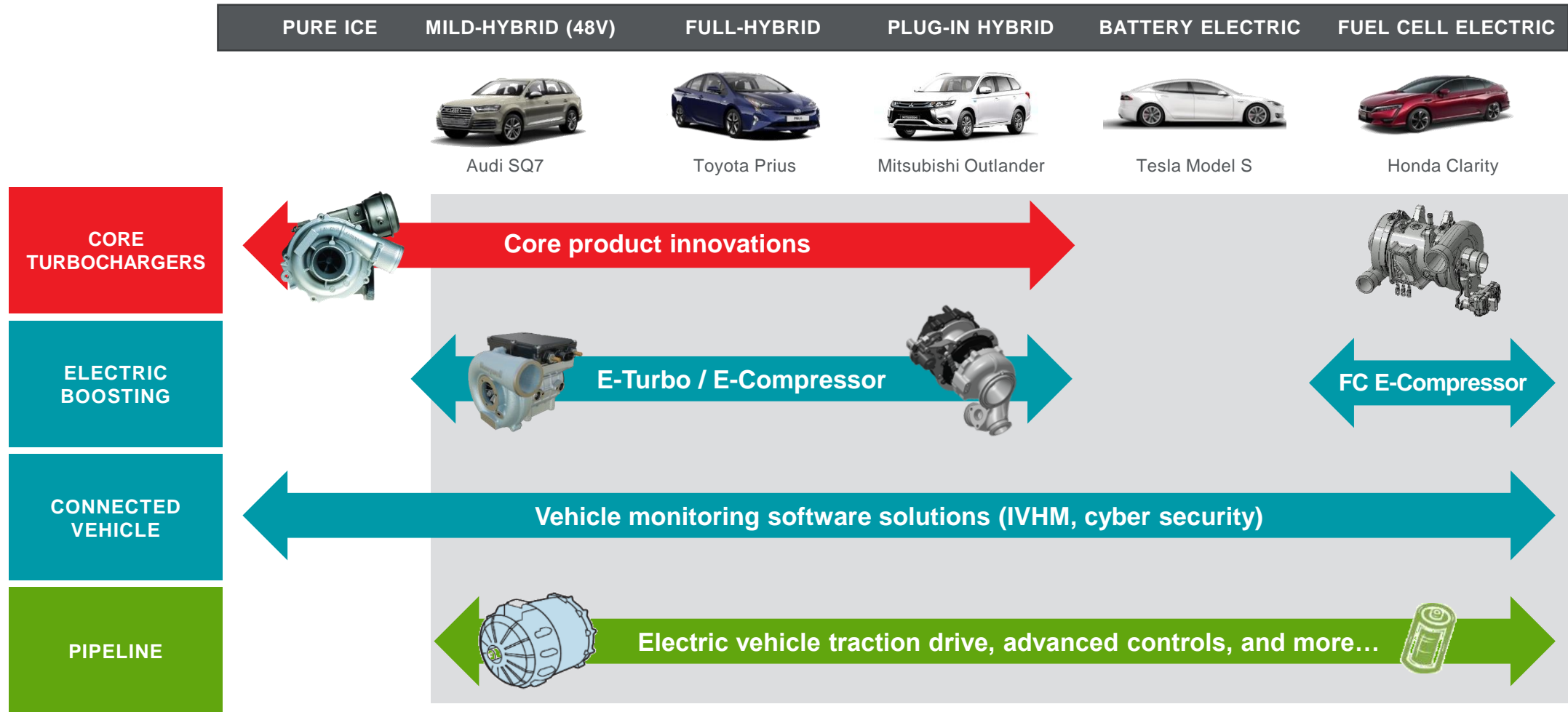

Note: ICE – Internal combustion engine; IVHM – Integrated vehicle health management; FC – Fuel cell

Copyrights © 2018 Garrett Motion Inc.

Leading position to benefit from electrification

3

Long-term co-development with global OEMs and a worldwide aftermarket platform

Global technology presence



● R&D center ● "Close-to-Customer" engineering center ● Software development center

5 R&D Centers

~1,200 Engineers

1,400+ Patents issued or pending

13 "Close-to-Customer" engineering centers

~100 Applications launched annually with 300 platforms being worked on at any given time

3

Long-term co-development with global OEMs and a worldwide aftermarket platform Customer Experience: Strong global relationships

| | PRE-DEVELOPMENT 4 YEARS | PRODUCT DEVELOPMENT 2 YEARS | VEHICLE PRODUCTION 3-5 YEARS | AFTERMARKET 10-15 YEARS | |
|----------------|---|--|---|--|---|
| KEY ACTIVITIES | INNOVATION | CUSTOMIZATION | MANUFACTURING | REPLACEMENT | <ul style="list-style-type: none"> • Serve nearly all OEMs • Single supplier per engine • High switching costs |
| BENEFITS | <p>New technology value assessment</p> <p>Early indication of technology trends</p> | <p>Early engagement and co-development</p> | <p>Limited resourcing risk</p> <p>Value Engineering opportunities</p> | <p>Revenue Stability</p> <p>Large Installed Base</p> | <ul style="list-style-type: none"> • 20+ years for each engine |

Long-term Customer Relationships

| | | | | | | | | |
|-----------------|-----------------|-----------------|-----------------|-----------------|-----------------|-----------------|-----------------|-----------------|
| | | | | | | | | |
| 63 YEARS | 40 YEARS | 40 YEARS | 38 YEARS | 35 YEARS | 33 YEARS | 32 YEARS | 30 YEARS | 25 YEARS |

3

Long-term co-development with global OEMs and a worldwide aftermarket platform

Early and broad customer engagement



Long-term view on technology trends

- We understand future powertrain needs and constantly adapt our innovation pipeline to stay ahead
- Innovation with customer growth and innovation extends beyond core turbo, to electrification and software technologies

Broadest portfolio of developments

- Unmatched launch and field experience benefiting our customers
- Go-to-partner for new technology developments

3

Long-term co-development with global OEMs and a worldwide aftermarket platform

Strong revenue visibility supported by robust win rate



Wins on key engine platforms

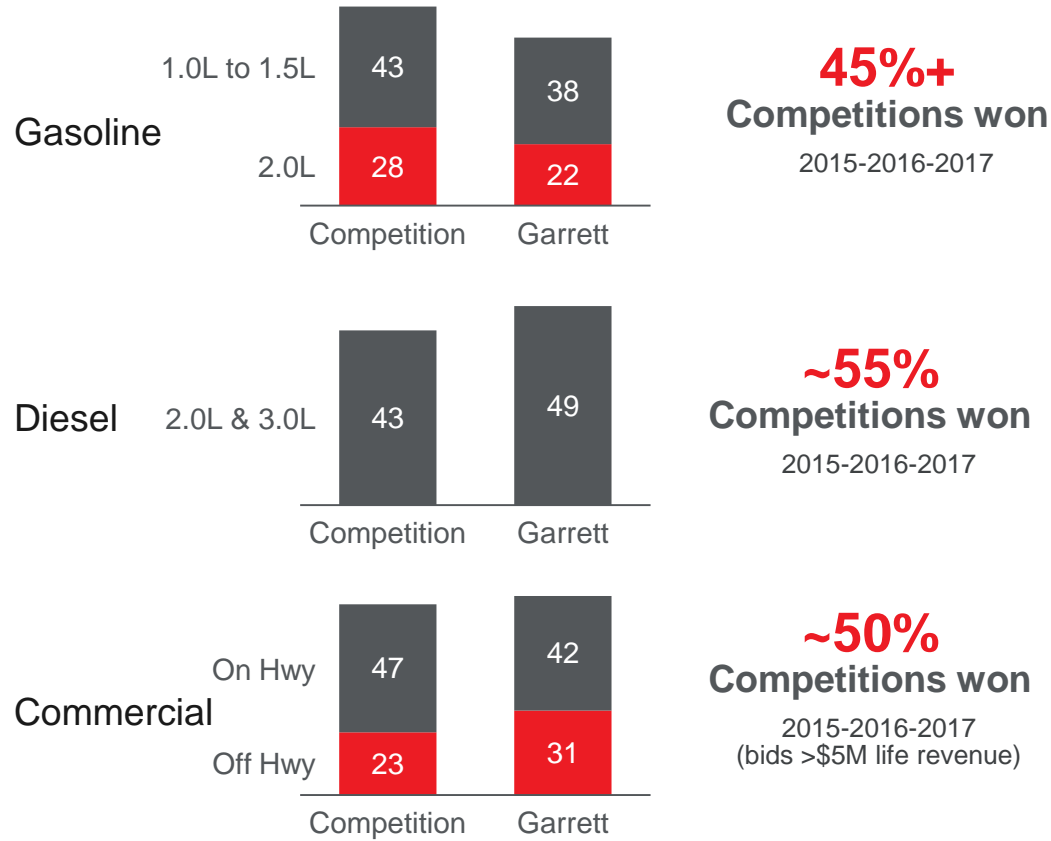

OEM revenue visibility¹

(% revenue awarded today for future years)

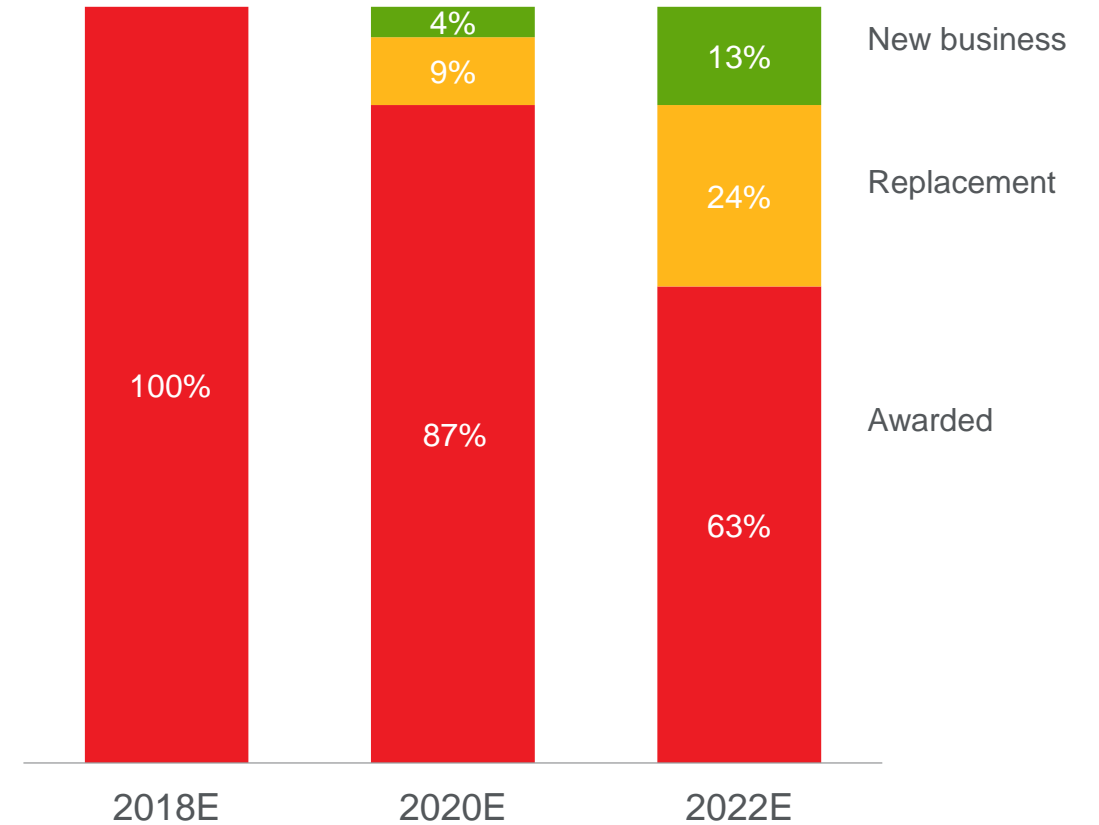

Note: Future revenues represent best estimates from Garrett based on current market conditions and potential other factors. Actual results may differ materially. Please see "Forward Looking Statements."

¹ Based on 2017 Revenue

Copyrights © 2018 Garrett Motion Inc.

3

Long-term co-development with global OEMs and a worldwide aftermarket platform

Customer Experience: Local player in China and India



China Highlights

- Local market player since 1994
- End-to-end development capability
- 200+ engineering staff in China
- Strong position with local OEMs
- East-for-East product line, cost leadership



JMC YUSHENG
2.4L DIESEL



SGM WL
1.5L GASOLINE



SHANQI F3000 /
WEICHAH WP10-12

India Highlights

- Serve almost every OEM in region
- Manufacturing plant in Pune
- R&D center in Bangalore
- 10 applications per year



FORD FIGO
ASPIRE
1.5L DIESEL



TATA 1.2L
GASOLINE



JOHN DEERE
2.9L

China and India revenues

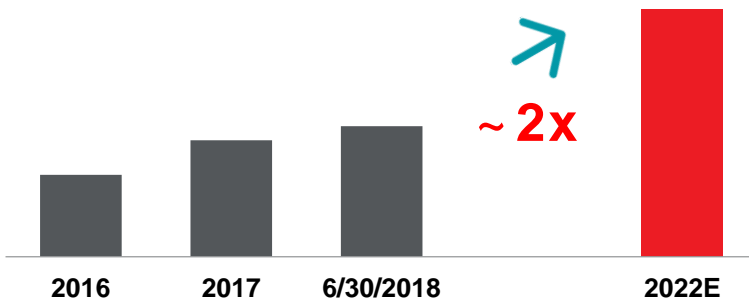

- Strong in country management teams
- Local production for local customers
- 30% of 2017 revenue from Asia (incl. Japan and Korea)
- Expect business to nearly double in next 5 years

Note: Future revenues represent best estimates from Garrett based on current market conditions and other factors. Actual results may differ materially. Please see "Forward Looking Statements."

Copyrights © 2018 Garrett Motion Inc.

3

Long-term co-development with global OEMs and a worldwide aftermarket platform

Strong aftermarket platform with brand equity

Broad aftermarket product portfolio

| | | |
|---|---|--|
| ORIGINAL EQUIPMENT / INDEPENDENT AFTERMARKET |  | <ul style="list-style-type: none"> • Original supply ensuring emission compliance • Distributors network |
| REMANUFACTURE |  | <ul style="list-style-type: none"> • Remanufacturing of OE design • Economic alternative with no trade-off on quality / durability |
| RED BOOST |  | <ul style="list-style-type: none"> • Economic turbo for high growth regions, with good reliability • Alternative to other Turbo original lines |
| PERFORMANCE & MOTORSPORTS |  | <ul style="list-style-type: none"> • Higher power, with reliability • 50 years of racing support |

Note: IAM – Independent aftermarket
Source: Garrett Management

#1 in global brand awareness

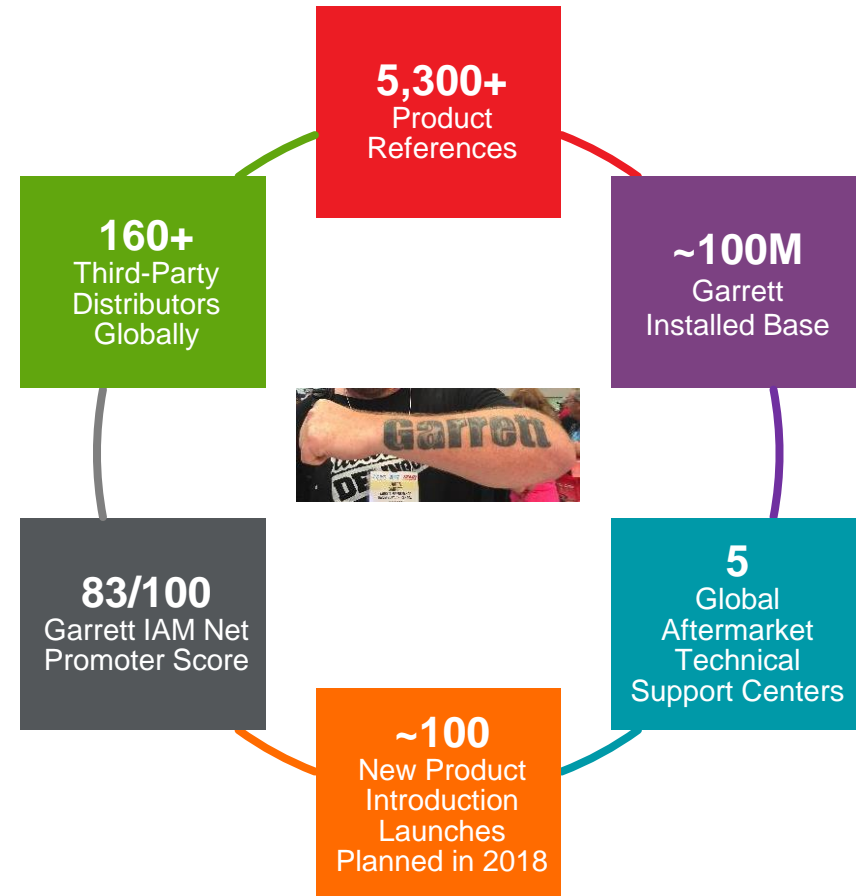

Copyrights © 2018 Garrett Motion Inc.

4

Best-in-class global manufacturing footprint with operational excellence and agility Integrated Supply Chain – A Global Operating System



13 state-of-the-art manufacturing facilities

4,500 employees across **17** countries

100% of footprint at HOS Silver+ maturity level

75%+ of capacity in high growth regions

100+ manufacturing patents and trade secrets

50,000+ turbos / day | **40** turbos / min

400 global suppliers, **70%** in HGR

5

Attractive financial profile

Strong financial performance

H1 2018 highlights

- Organic revenue growth of **7%**
- Consolidated EBITDA margin of **20%**^{1,2}
- Consolidated EBITDA less Adj. capital expenditures³ conversion rate of **90%**^{1,2,4}
- Adj. capital expenditures³ **~2%** of net revenues



Turbo Technology



Electric & Hybrid



Connected Vehicles

¹ Consolidated EBITDA is a Non-GAAP financial measure; please refer to the Appendix for its definition and a reconciliation to Net Income and Adjusted EBITDA as presented in the Form 10

² Excludes Honeywell Indemnity Obligation payment and FX impact

³ Adj. capital expenditures is a Non-GAAP financial measure; please refer to the Appendix for its definition and a reconciliation to reported capital expenditures

⁴ Defined as (Consolidated EBITDA less Adj. capital expenditures) / Consolidated EBITDA

Garrett is a cutting-edge technology provider that enables vehicles to become safer, more connected, efficient and environmentally friendly

- Differentiated technology / Broad innovative product portfolio
- Best-in-class global manufacturing / Operational excellence / Low cost
- Deep-seated customer relationship / Local player in HGRs



Turbo Technology



Electric & Hybrid



Connected Vehicles

Garrett is emerging as an independent company from a position of strength



“...the Turbo equity story is outstanding. This is a market leader that's continuing to gain share, and that's not me selling. That's reality based on the kind of win rates that we are seeing in Turbo Technologies. And now you combine that with some of these new growth vectors that they're pursuing, whether it be cyber or vehicle maintenance or e-turbos, it's an absolutely outstanding franchise.”

Darius Adamczyk, Chairman & CEO of Honeywell

Technology Overview

Craig Balis - CTO



2

Technology leadership and broad portfolio of products with breakthrough capabilities

Technology at Garrett

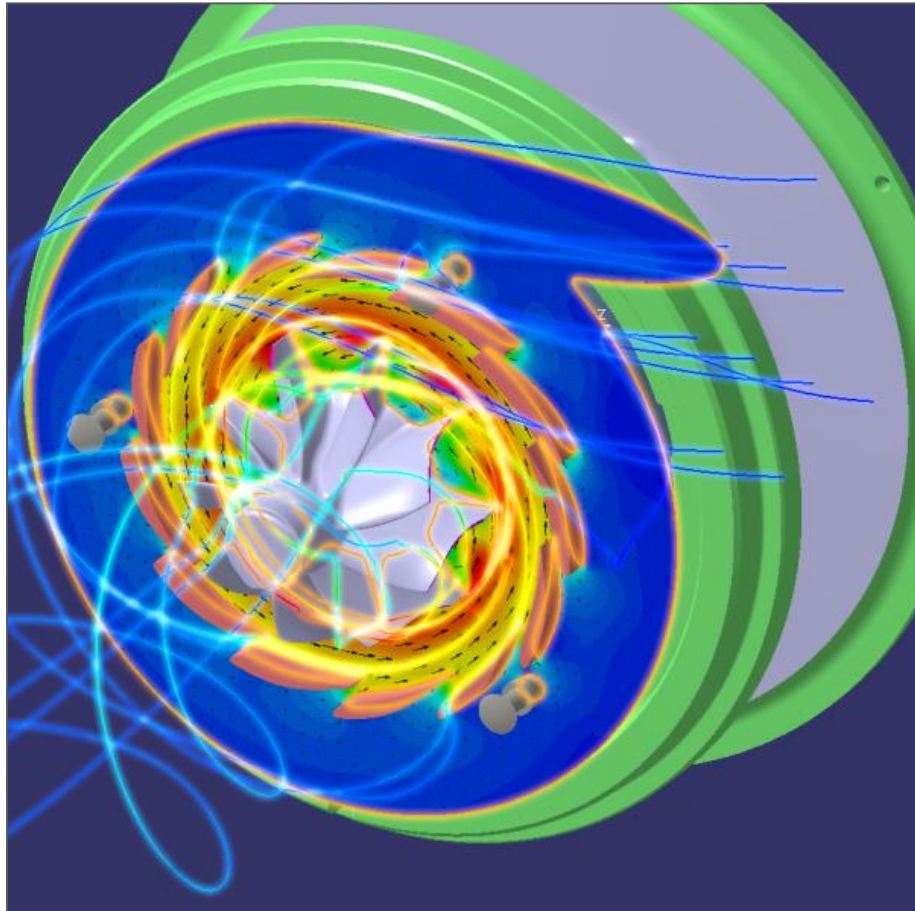

- Technology-driven growth, propelled by industry macros
- Cutting edge technical solutions on turbo, electrification, and software
- Strong customer collaboration which accelerates innovations to market

Technology growth strategy

CORE TURBO

- Strong global macros, turbo is a core enabling solution for OEMs
- Advanced technology that we have mastered and differentiated
- Core turbo innovation and new content required by advanced powertrains

ELECTRIFICATION & SOFTWARE

- Hybrid and connected vehicles creating opportunities for new technologies
- Developing differentiated solutions from cross-Honeywell incubators
- E-Boosting, Cyber Security and Integrated Vehicle Health Management

PIPELINE

- Building on core competencies
- Applying high speed motors and model-based controls to new challenges
- Exciting new concepts pipeline in proof-of-concept with customers

Technology growth strategy

CORE TURBO

- Strong global macros, turbo is a core enabling solution for OEMs
- Core turbo innovation required by advanced powertrains
- Advanced technology that we have mastered and differentiated

ELECTRIFICATION & SOFTWARE

- Hybrid and connected vehicles creating opportunities for new technologies
- Developing differentiated solutions from X-Honeywell incubators
- e-Boosting, Cyber Security and Integrated Vehicle Health Management

PIPELINE

- Building on core competencies
- Applying high speed motors and model-based controls to new challenges
- Exciting new concepts pipeline in Proof of Concept with customers

2

Technology leadership and broad portfolio of products with breakthrough capabilities

Turbocharging – technology at the cutting edge



Journal bearing clearance
~ 0.0004 inches of oil film...
... 7 times thinner than human hair

From 50,000 RPM to 200,000 RPM
in less than 2 seconds...
... 3 seconds for F-16 engine to spool up to maximum thrust

Average compressor flow
~ 20 cubic meters per minute...
... the capacity of a utility van

Wheels tip speed
~1,300 miles per hour...
... supersonic, more than
1.7 times the speed of sound

Being shaken
at 25g vibration level...
... fighter jets can withstand ~14g

Rotor group rotating speed
can reach 350,000 revolutions per minute...
... B787 engines reach only 14,000 RPM

Turbine inlet temperature
Over 1,900 degrees Fahrenheit...
... window glass melts at 1,800 degrees Fahrenheit

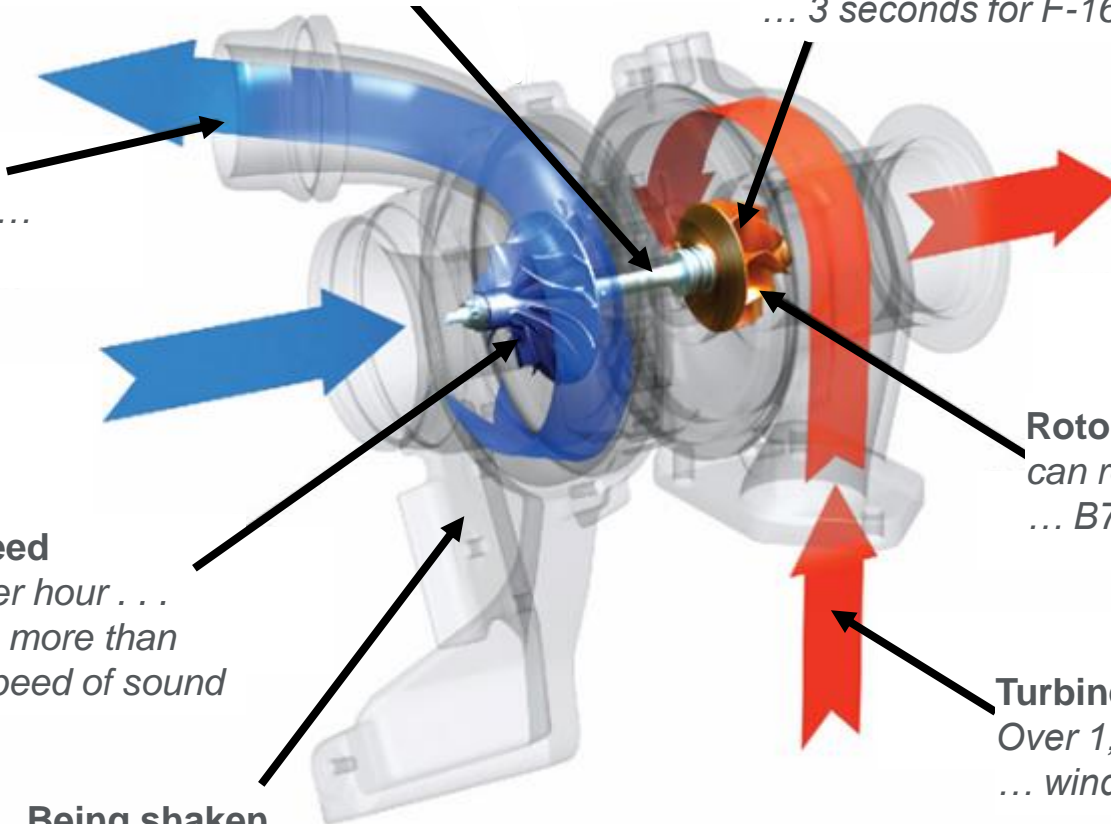

2

Technology leadership and broad portfolio of products with breakthrough capabilities

Modern powertrains need a turbo

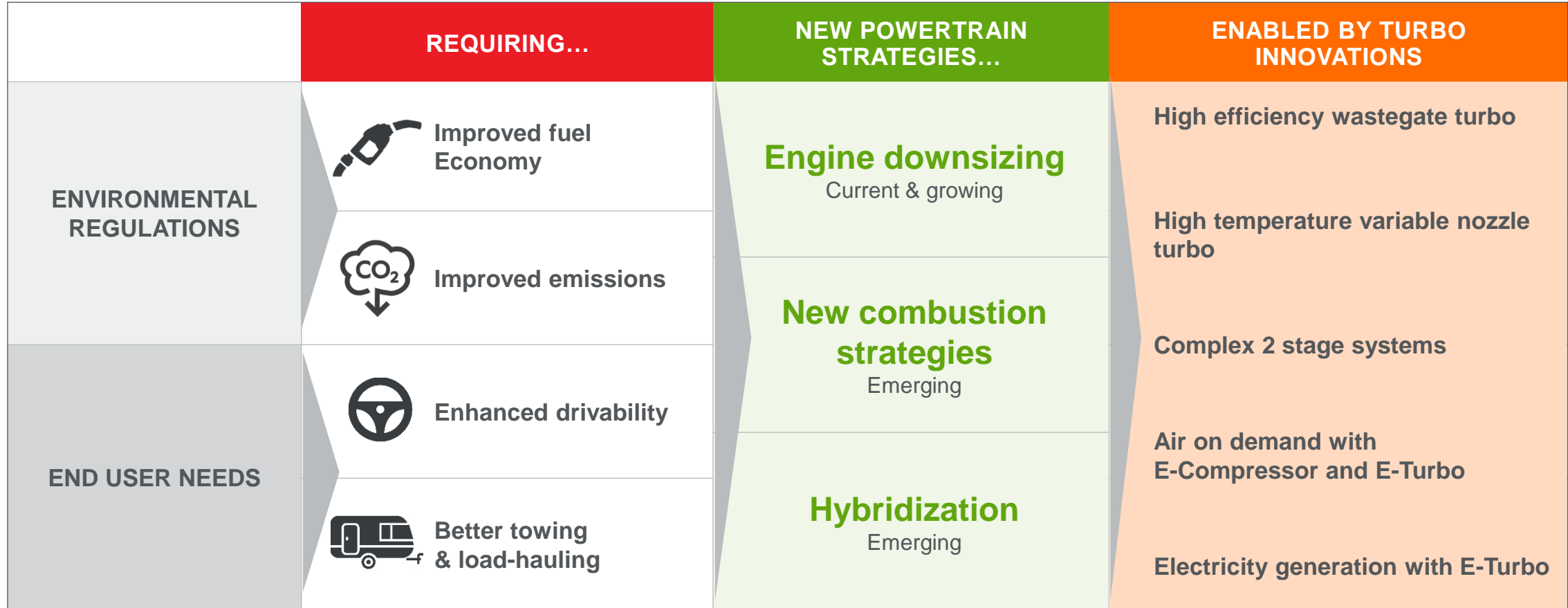

2

Technology leadership and broad portfolio of products with breakthrough capabilities

Example of gasoline powertain

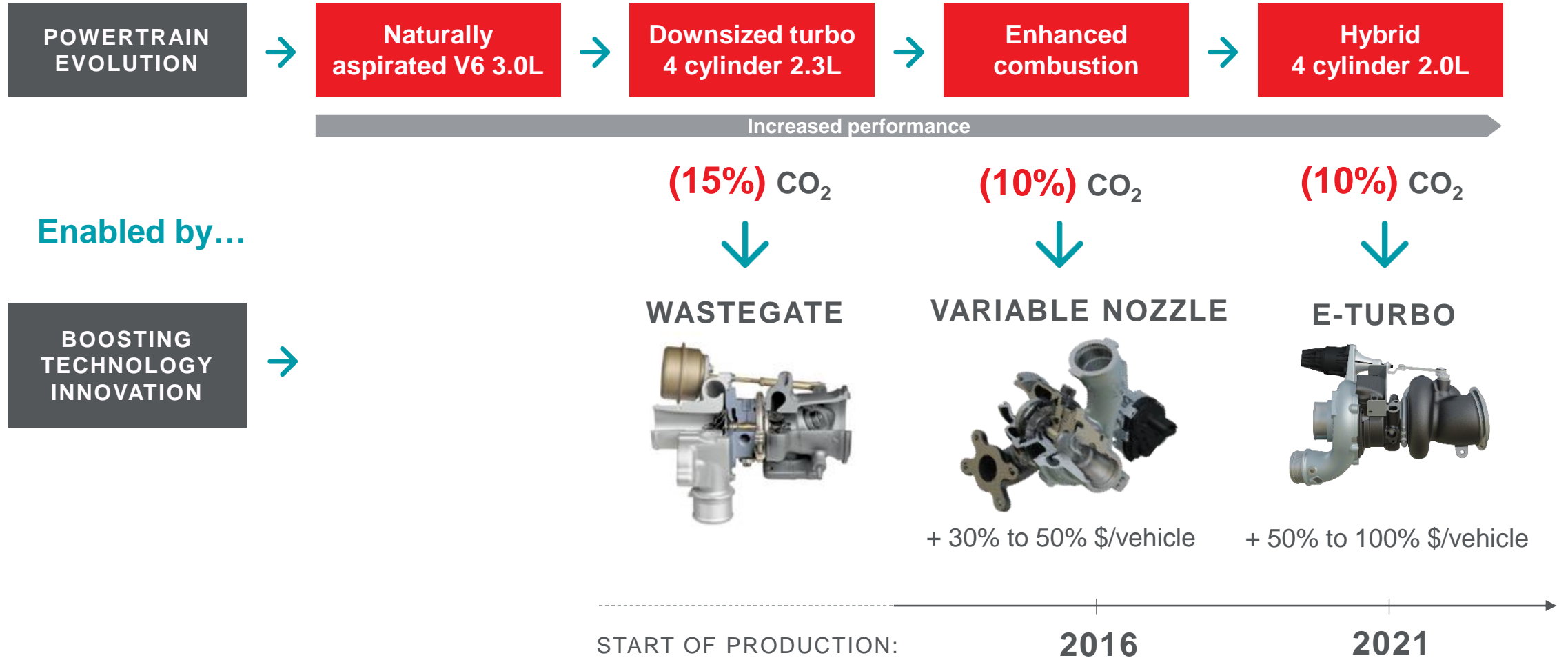

Copyrights © 2018 Garrett Motion Inc.

2

Technology leadership and broad portfolio of products with breakthrough capabilities

Engineering footprint aligned with customers

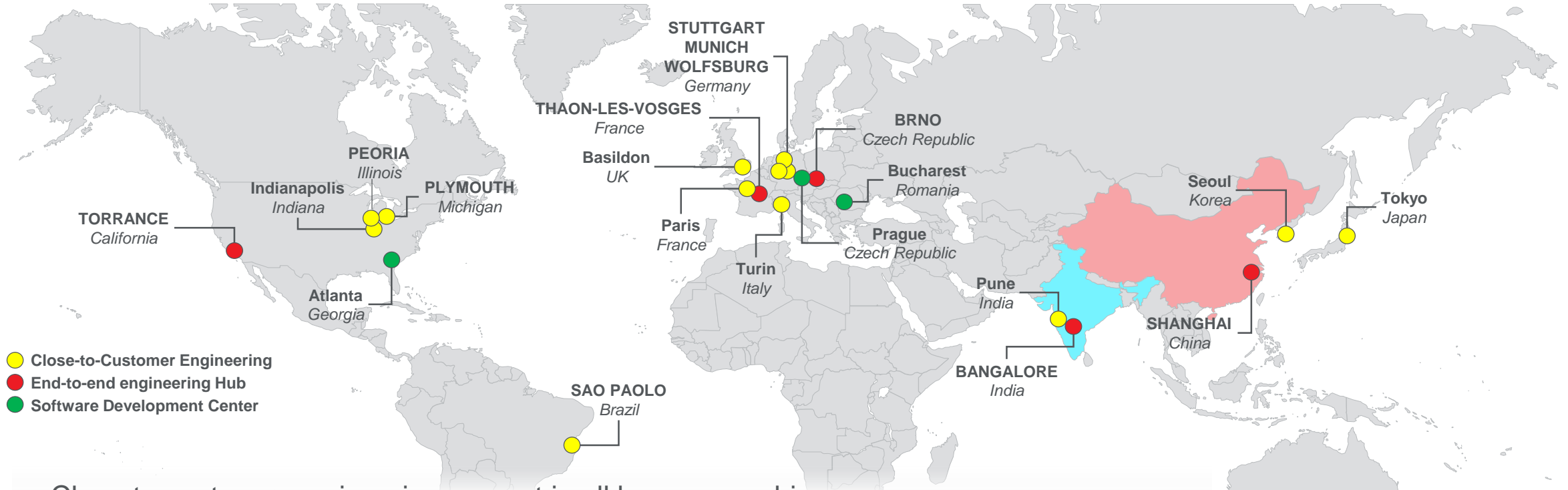

- Close-to-customer engineering support in all key geographies
- 5 engineering hubs with full end-to-end capabilities +3 specialized software hubs
- China & India:
 - 30% of total engineering resources
 - Full development ownership of local products fit for local markets

Technology growth strategy

CORE TURBO

- Strong global macros, turbo is a core enabling solution for OEMs
- Core turbo innovation required by advanced powertrains
- Advanced technology that we have mastered and differentiated

ELECTRIFICATION & SOFTWARE

- Hybrid and connected vehicles creating opportunities for new technologies
- Developing differentiated solutions from cross-Honeywell incubators
- E-Boosting, Cyber Security and Integrated Vehicle Health Management

PIPELINE

- Building on core competencies
- Applying high speed motors and model-based controls to new challenges
- Exciting new concepts pipeline in Proof of Concept with customers

2

Technology leadership and broad portfolio of products with breakthrough capabilities

Turbocharging electrified powertrains

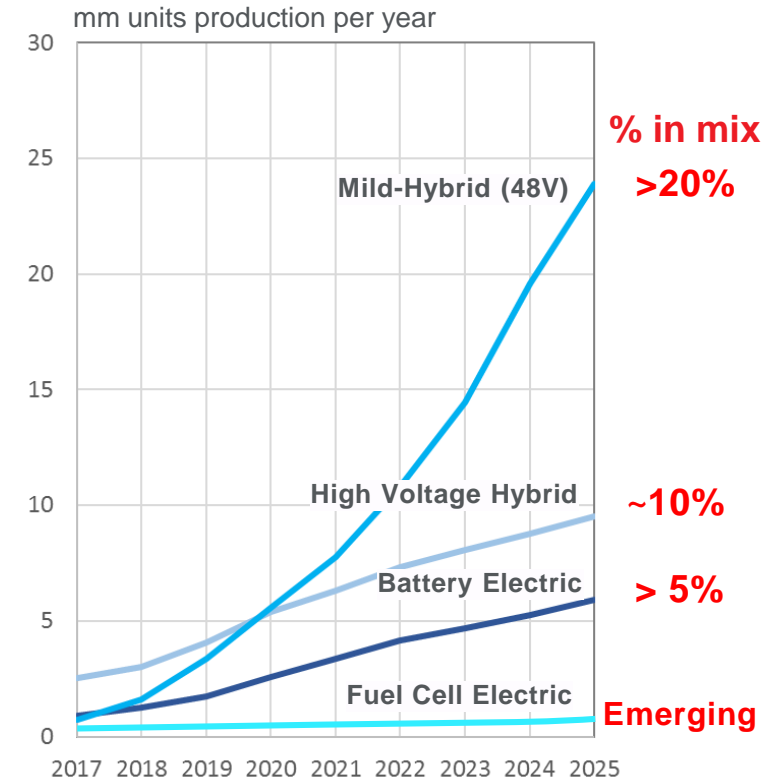
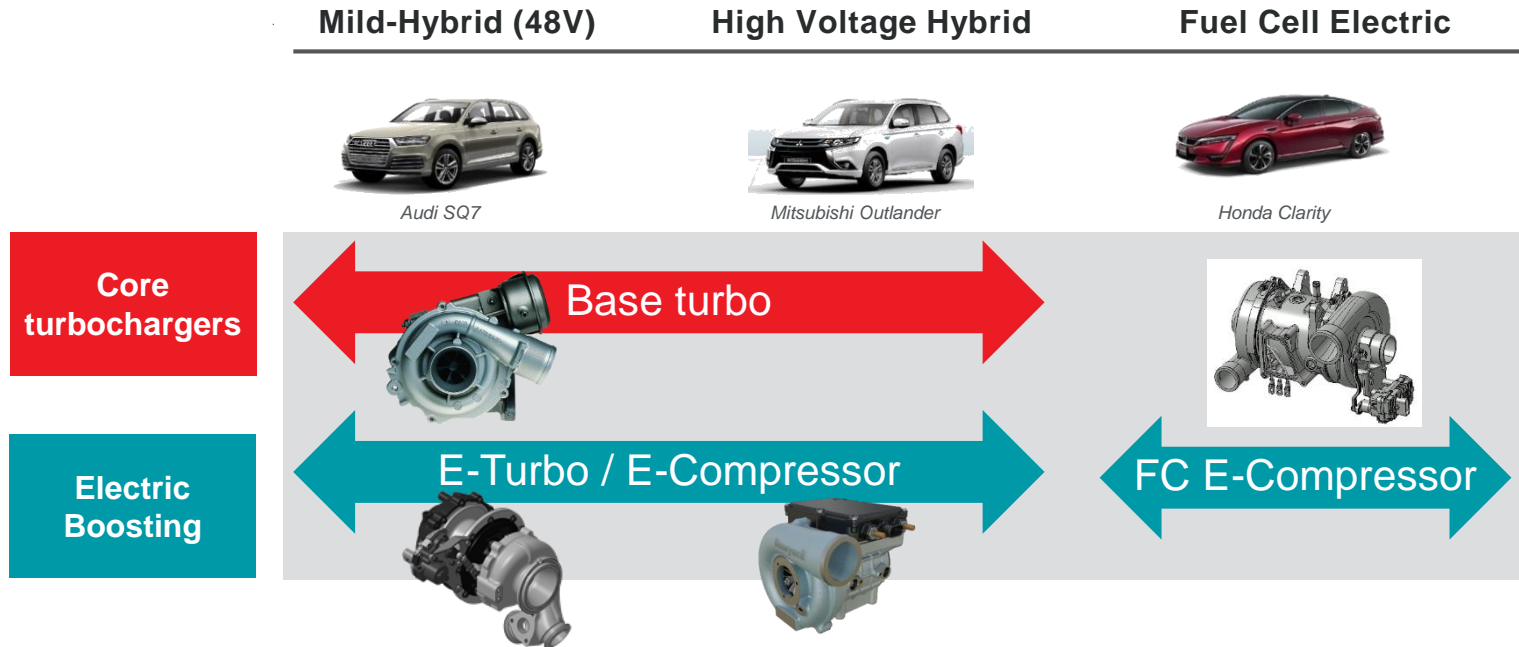

- 76% hybrids powertrain turbocharged by 2025, 100% hydrogen fuel cell
- Full CO₂ potential unlocked with electric boosting
- Electric vehicle with hydrogen fuel cell requiring high performance E-Compressor

Note: ICE - Internal combustion engine; Source: IHS

Copyrights © 2018 Garrett Motion Inc.

2

Technology leadership and broad portfolio of products with breakthrough capabilities

E-Boosting is a great fit with hybrids

Two ways to use available electric power in a hybrid powertrain

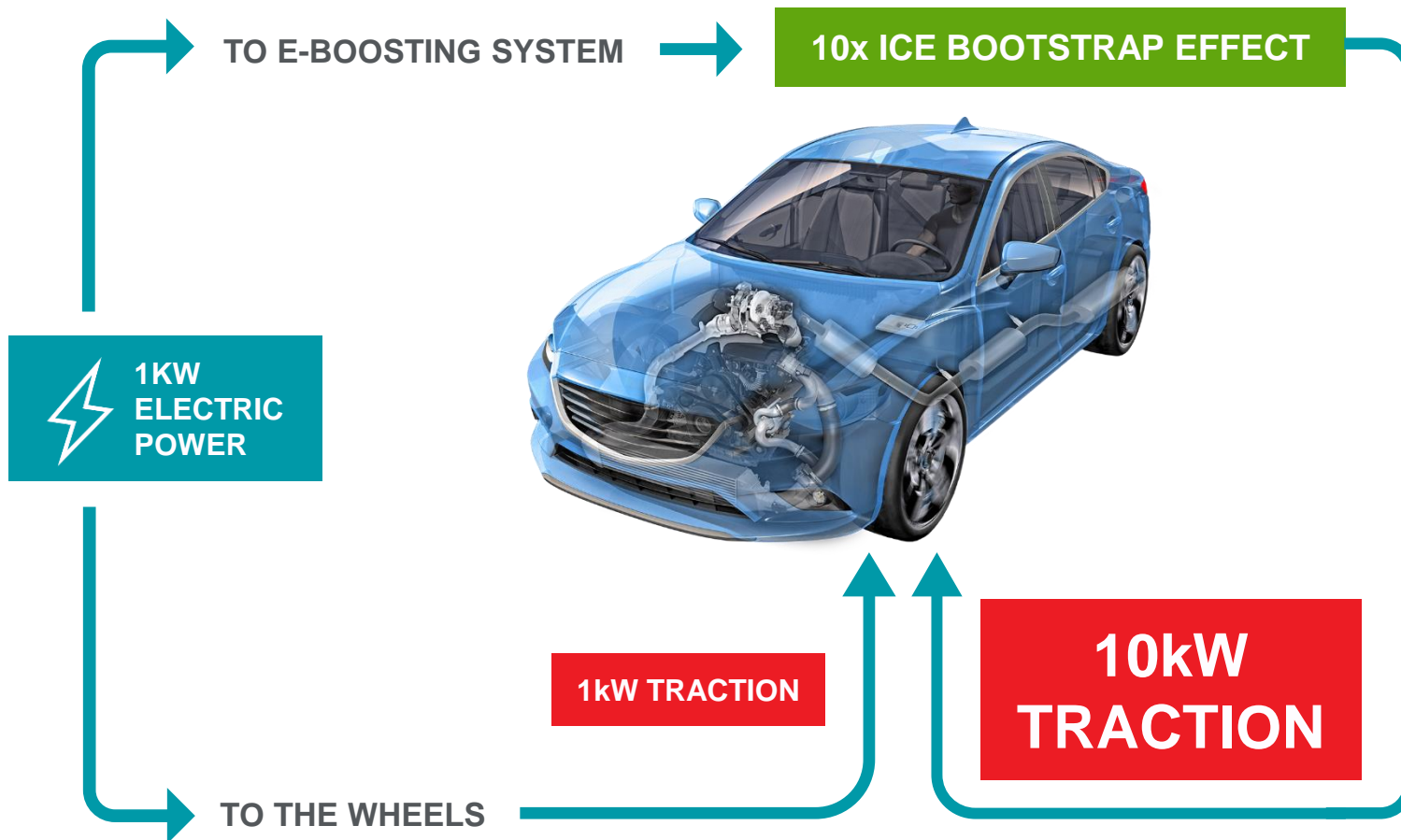

Two E-Boosting Solutions

E-Compressor + Turbo

- Paired with a turbo
- Best vehicle dynamics



E-Turbo



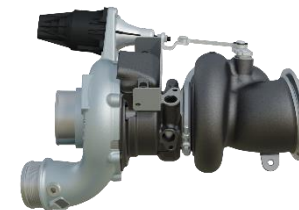



- Integrated solution
- Can generate electricity

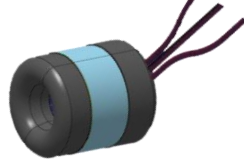

2

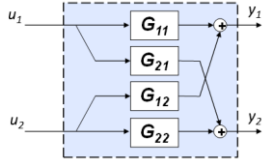
Technology leadership and broad portfolio of products with breakthrough capabilities

E-Boosting... expanding scope beyond turbo

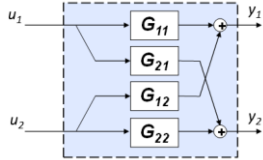
| | CORE TURBO CONTENT | E-BOOSTING CONTENT | | ADDITIONAL SOFTWARE CONTENT |
|----------------------|---|---|--|--|
| E-TURBO | <p>BASE TURBO</p>  | <p>E-MOTOR</p>  | <p>HIGH SPEED CONTROLLER</p>  | <p>ENGINE CONTROL MODULE</p>  |
| E-COMPRESSOR + TURBO | <p>BASE TURBO</p>  | <p>E-COMPRESSOR</p>  | <p>HIGH SPEED CONTROLLER</p>  | <p>ENGINE CONTROL MODULE</p>  |
| GARRETT LEADERSHIP | <p>Core turbo innovation</p> | <p>Differentiated high-speed motors and electronics</p> | | <p>Proprietary advanced model-based controls</p> |

Hydrogen fuel cell electric vehicle opportunity

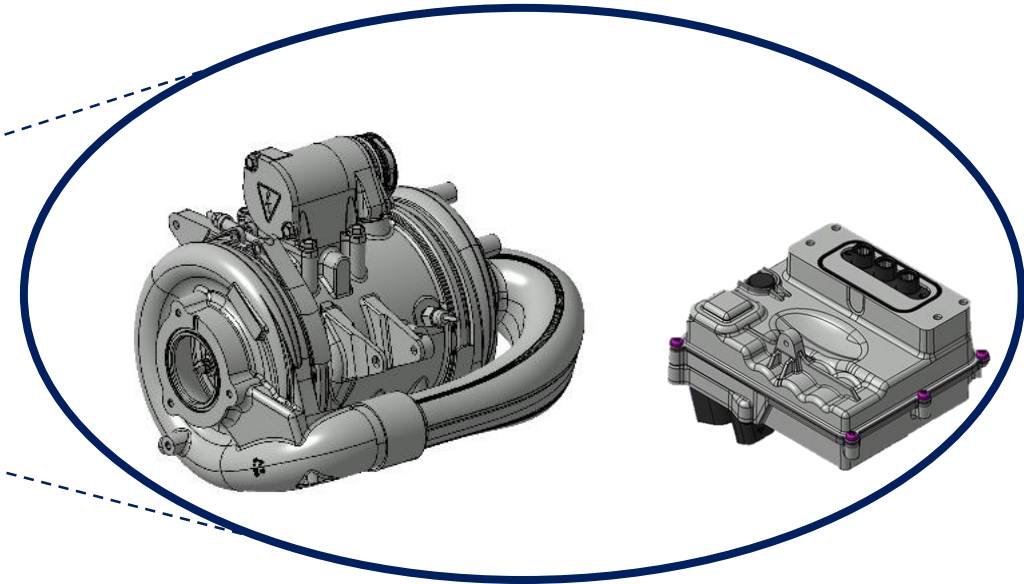
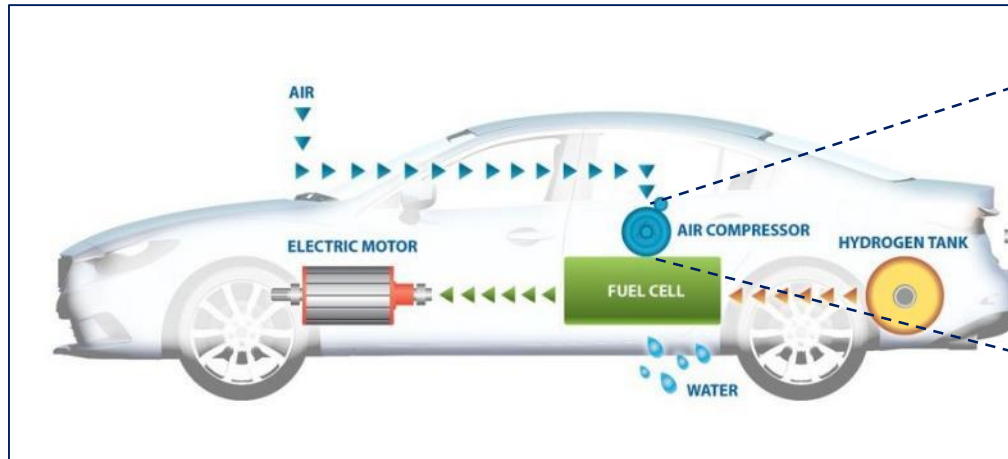

Hydrogen fuel cell benefits

- Zero emission (electric traction)
- Real life long range (500-600km)
- Short refueling time (3-5 min)
- Small low cost battery

Favorable government policies in Japan, China, EU, US CARB¹ states

¹ The US states that have adopted California standards

Need high performance E-Compressor

- Garrett in production since 2016
- Synergies with overall E-Boosting activities
- Differentiated technologies (high speed motor & electronics, oil less bearing, system integration)

Engaged in >10 projects with OEMs

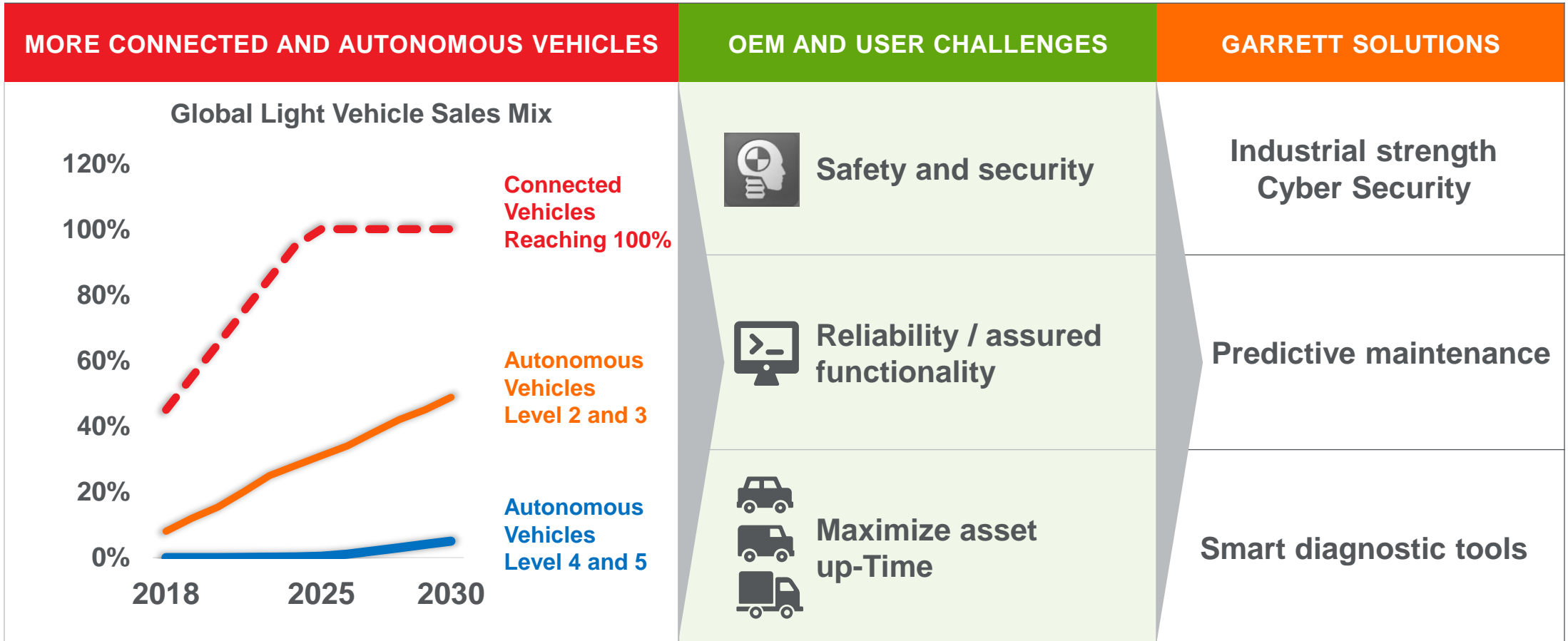

2

Technology leadership and broad portfolio of products with breakthrough capabilities

Garrett vehicle monitoring offering

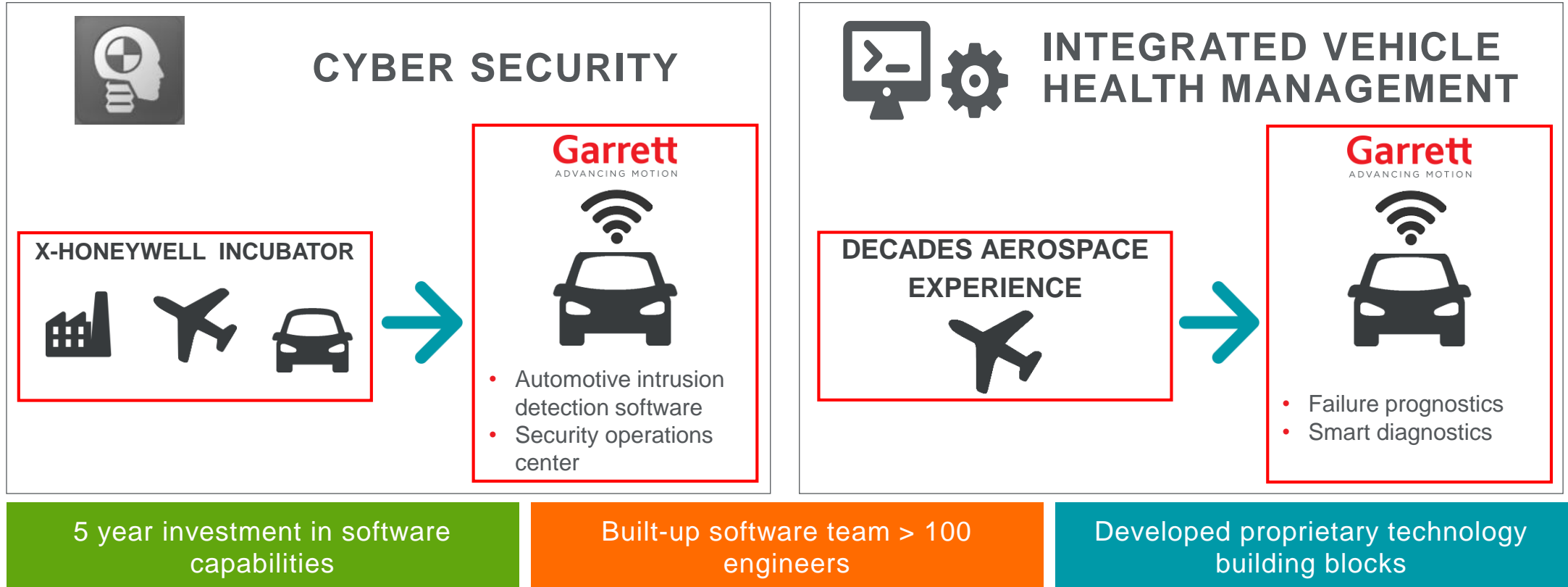

- Multiple pilots with customers

- Several partnership with Tier 1's

2

Technology leadership and broad portfolio of products with breakthrough capabilities

Technology growth strategy

CORE TURBO

- Strong global macros, turbo is a core enabling solution for OEMs
- Core turbo innovation required by advanced powertrains
- Advanced technology that we have mastered and differentiated

ELECTRIFICATION & SOFTWARE

- Hybrid and connected vehicles creating opportunities for new technologies
- Developing differentiated solutions from X-Honeywell incubators
- e-Boosting, Cyber Security and Integrated Vehicle Health Management

PIPELINE

- Building on core competencies
- Applying high speed motors and model-based controls to new challenges
- Exciting new concepts pipeline in Proof of Concept with customers

2

Technology leadership and broad portfolio of products with breakthrough capabilities Leveraging Garrett capabilities for growth pipeline

KEY COMPANY STRENGTHS



Turbo Technology



Electric & Hybrid



Connected Vehicles



- High speed rotation
- High precision
- High temperature



- High speed motors
- High speed controller
- System integration



- Model-based anomaly detection
- Physics-based prognostics & diagnostics
- Advanced multi-variate non-linear controls



- Electric Vehicle traction drive
- Advanced control software and analytics
- ... and more

2

Technology leadership and broad portfolio of products with breakthrough capabilities

Technology at Garrett

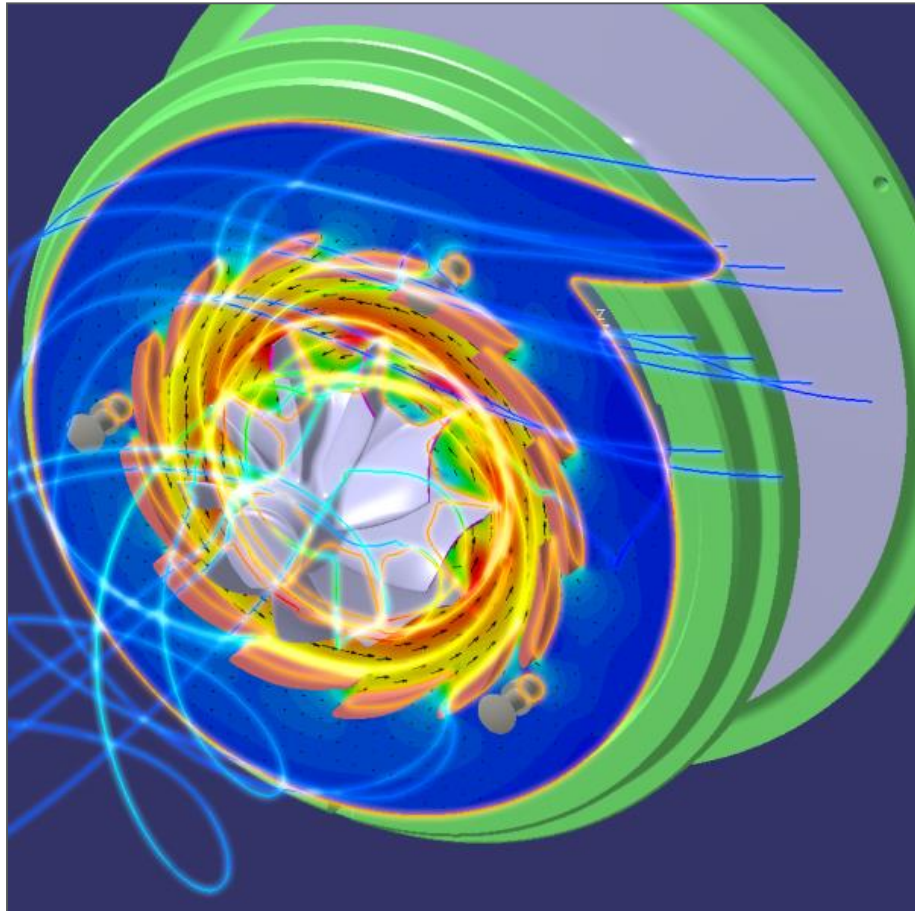

- Technology-driven growth, propelled by industry macros
- Cutting edge technical solutions on turbo, electrification, and software
- Strong customer collaboration which accelerates innovations to market

Operational Overview

Thierry Mabru - SVP
Integrated Supply Chain



4

Best-in-class global manufacturing footprint with operational excellence and agility

Differentiated integrated supply chain strategy



- Highly differentiated manufacturing capability
- Low cost - leading operating system
- Advanced supply base management

4

Best-in-class global manufacturing footprint with operational excellence and agility Integrated Supply Chain – A Global Operating System



13 state-of-the-art manufacturing facilities

4,500 employees across **17** countries

100% of footprint at HOS Silver+ maturity level

75%+ of capacity in high growth regions

100+ manufacturing patents and trade secrets

50,000+ turbos / day | **40** turbos / min

400 global suppliers, **70%** in HGR

4

Best-in-class global manufacturing footprint with operational excellence and agility

Highly differentiated manufacturing



Differentiated internal manufacturing technologies

- Home-grown “Industry firsts” for high-speed electron-beam and laser welding
- Proprietary super high speed balancing
- 100+ manufacturing patents and trade secrets

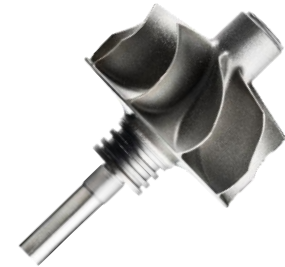

Leverage supply base scale

- Low vertical integration | >80% of costs sourced from suppliers
- Optimized CAPEX and limited working capital and fixed cost

Drive make vs. buy competition on strategic technologies

- Selective investments in promising strategic technologies
- Knowledge build up for effective design to cost and competitive sourcing
- Only turbo player to operate high grade wheel foundry

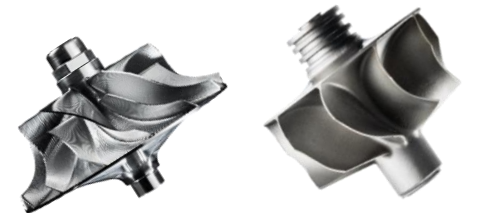

Copyrights © 2018 Garrett Motion Inc.

4

Best-in-class global manufacturing footprint with operational excellence and agility

Low cost – Leading operating system



75%+ of capacity in high growth regions

- Closure of Italy in H1 2018
- Slovakia and China greenfields ramped up to full maturity in 5 years
- Biggest Turbo factory in Bucharest, Romania



Standardized manufacturing processes

- Global engine programs sourced from multiple plants
- Maximized flexibility and assets utilization
- Resilience to industrial risks

High-efficiency operations

- Heavy contributor to Honeywell operating system (HOS)
- Only Honeywell Business with 100% HOS Silver+ sites
- Superior safety, quality and service performance
- 100+ new product launches in production every year



Copyrights © 2018 Garrett Motion Inc.

4

Best-in-class global manufacturing footprint with operational excellence and agility

Advanced supply base management

Supplier's Development and localization

- 400+ global suppliers, 70% of spend in HGR
- 20+ new suppliers developed in HGR over the last 3 years



Driving Innovation at Suppliers

- 10+ technology development exclusivity agreements in place
- Development of Garrett proprietary materials
- Ready for electrification (high-speed motors, electronics)

Operational Excellence

- Proprietary target costing tools and processes
- Industry leading team of supplier development experts
- Comprehensive supply base risk management



4

Best-in-class global manufacturing footprint with operational excellence and agility Driving to the lowest cost / highest performance

- Global and scalable footprint, 75%+ in high growth regions
- Make-vs-buy driven by technology differentiation and value retention
- Comprehensive supply base management
- Differentiated and stringent KPIs (safety, quality, delivery, inventory and cost)
- Strong track record of continuous productivity – Driving for lowest cost



Turbo Technology



Electric & Hybrid



Connected Vehicles

FINANCIAL OVERVIEW

Alessandro Gili - CFO



5

Attractive financial profile

Solid track record of consistent performance



Net revenue

(\$mm)

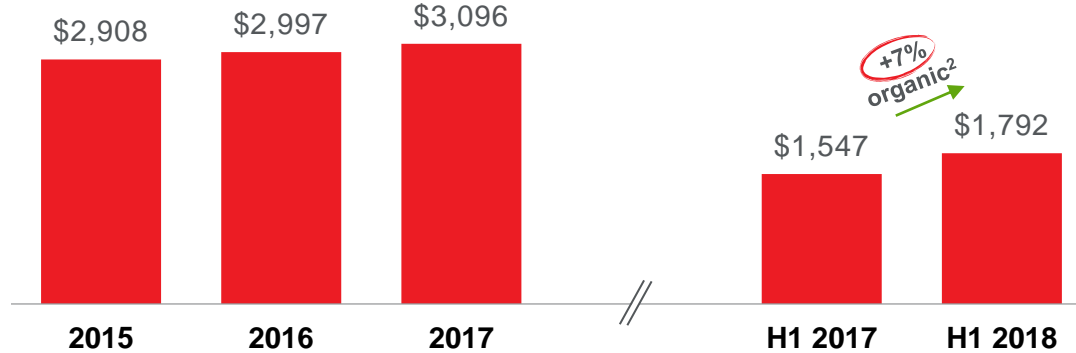

Consolidated EBITDA¹

(\$mm)

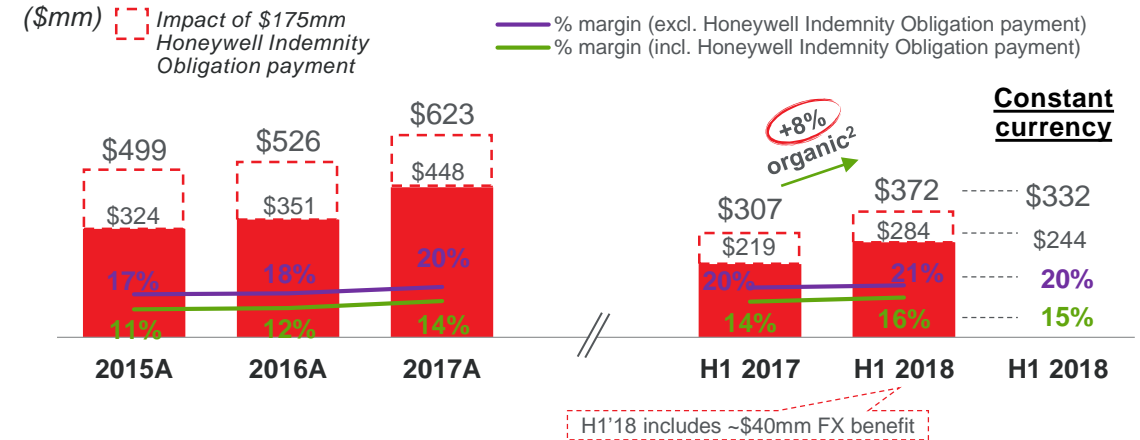

Adj. capital expenditures³

(\$mm)

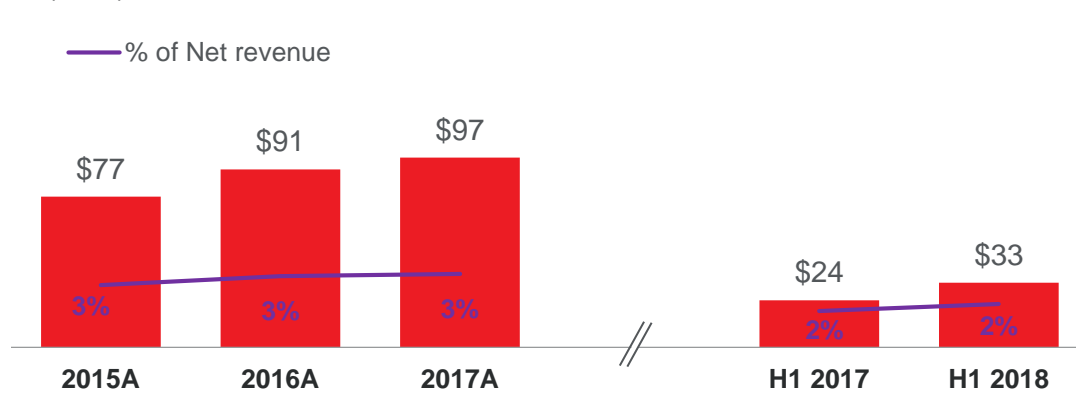

Consolidated EBITDA¹ – Adj. capital expenditures³

(\$mm), excluding Honeywell Indemnity Obligation payment

X% = (Consolidated EBITDA less Adj. capital expenditures) / Consolidated EBITDA

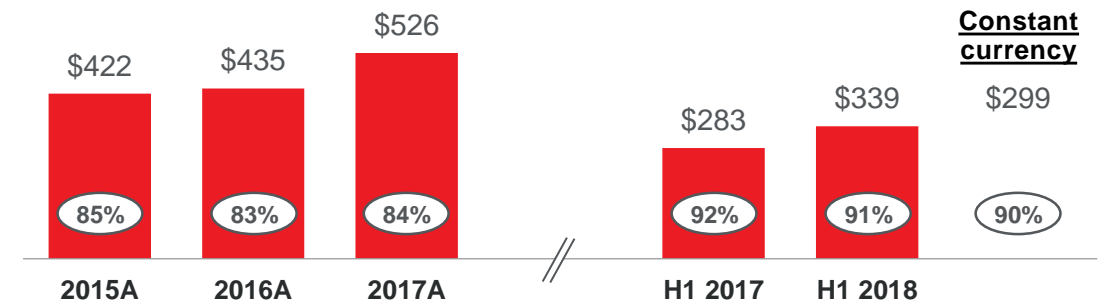

¹ Consolidated EBITDA is a Non-GAAP financial measure; please refer to the Appendix for its definition and a reconciliation to Net Income and Adjusted EBITDA as presented in the Form 10

² Constant currency, excluding FX impact

³ Adj. capital expenditures is a Non-GAAP financial measure; please refer to the Appendix for its definition and a reconciliation to reported capital expenditures

5

Attractive financial profile

Revenue bridge: 2015 – 2017

(\$mm)

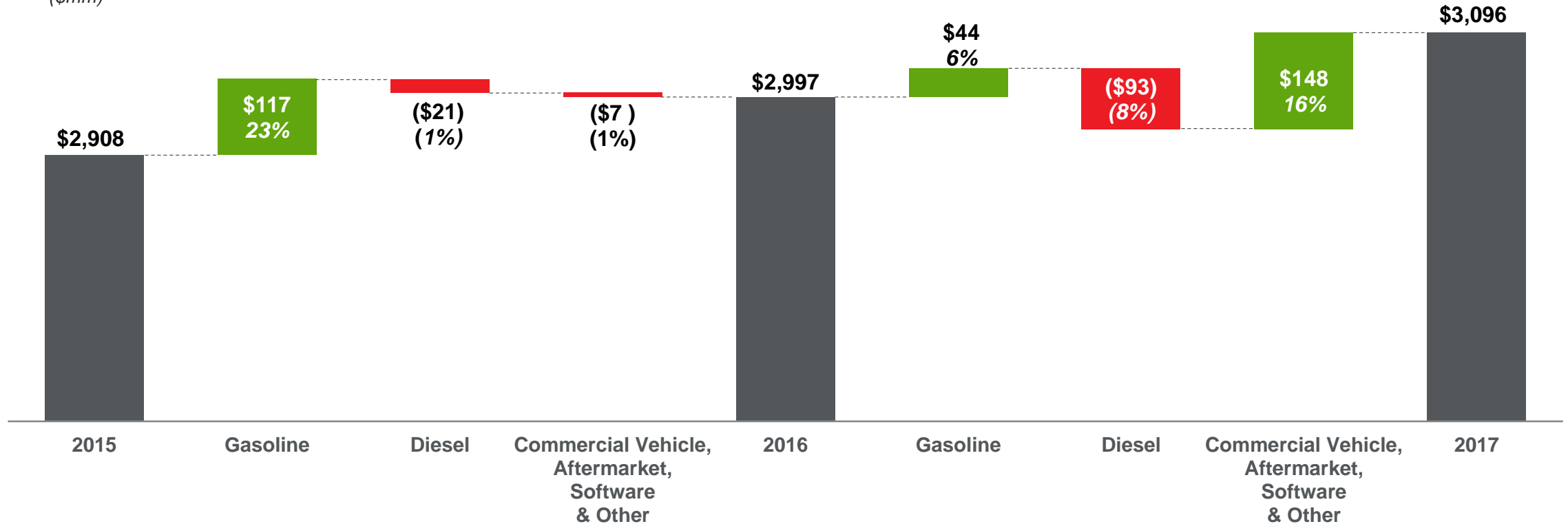

3% Organic growth
Growth driven by gasoline +23%

3% Organic growth
Growth mainly from commercial vehicles +16%
Diesel impacted by industry dynamics

Note: All growth in % are organic

5

Attractive financial profile

Revenue bridge: H1 2017 – H1 2018

(\$mm)

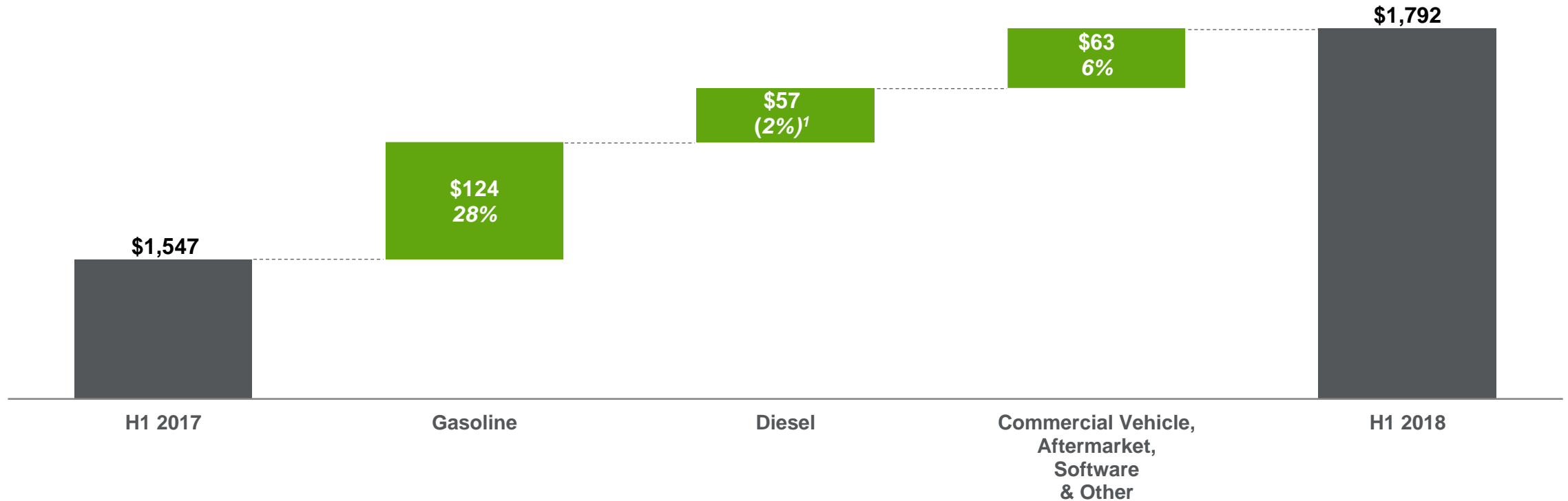

28% Organic growth in gasoline

(2%) Organic decline in diesel

6% Organic growth in commercial vehicles and new initiatives

Note: All growth in % are organic
¹ Diesel Up 8% Reported, Down 2% Organic

5

Attractive financial profile

Strong revenue visibility

OEM revenue visibility

(% revenue awarded today for future years)

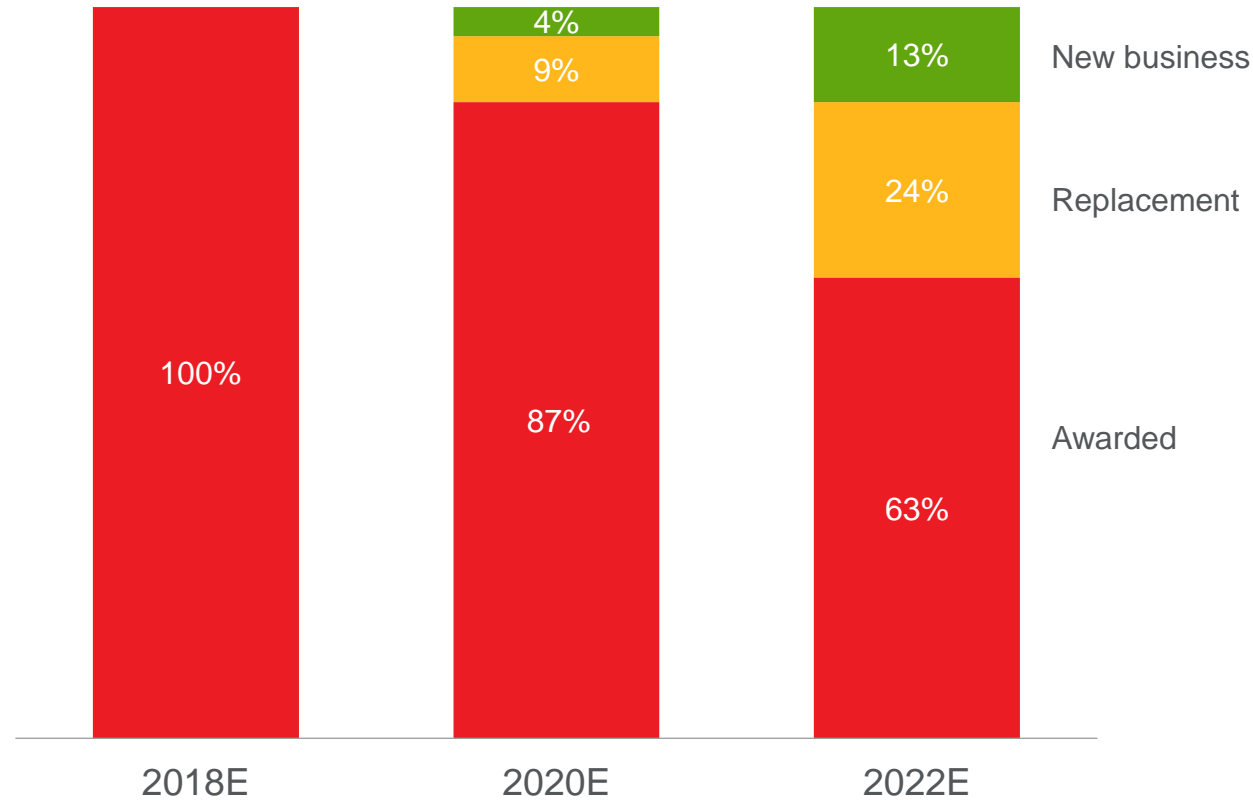

Takeaways

- Near-term revenue nearly 100% booked
- 2022E awarded trends are consistent with what the business has seen historically
- 2022E awarded and replacement revenue in excess of 2018E revenue
- OEMs award one supplier per engine due to high level of customization of turbochargers
- Revenue visibility further supported by resilient aftermarket revenue

Revenue by Geography¹

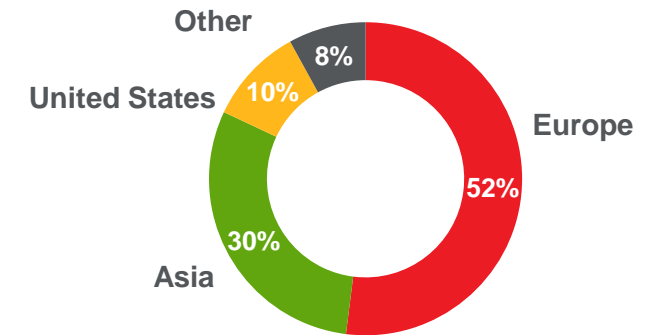

Note: Future revenues represent best estimates from Garrett based on current market conditions and other factors. Actual results may differ materially. Please see "Forward Looking Statements."

¹ Based on 2017 Revenue

Copyrights © 2018 Garrett Motion Inc.

5

Attractive financial profile

Garrett has a well-positioned cost structure

Cost structure evolution

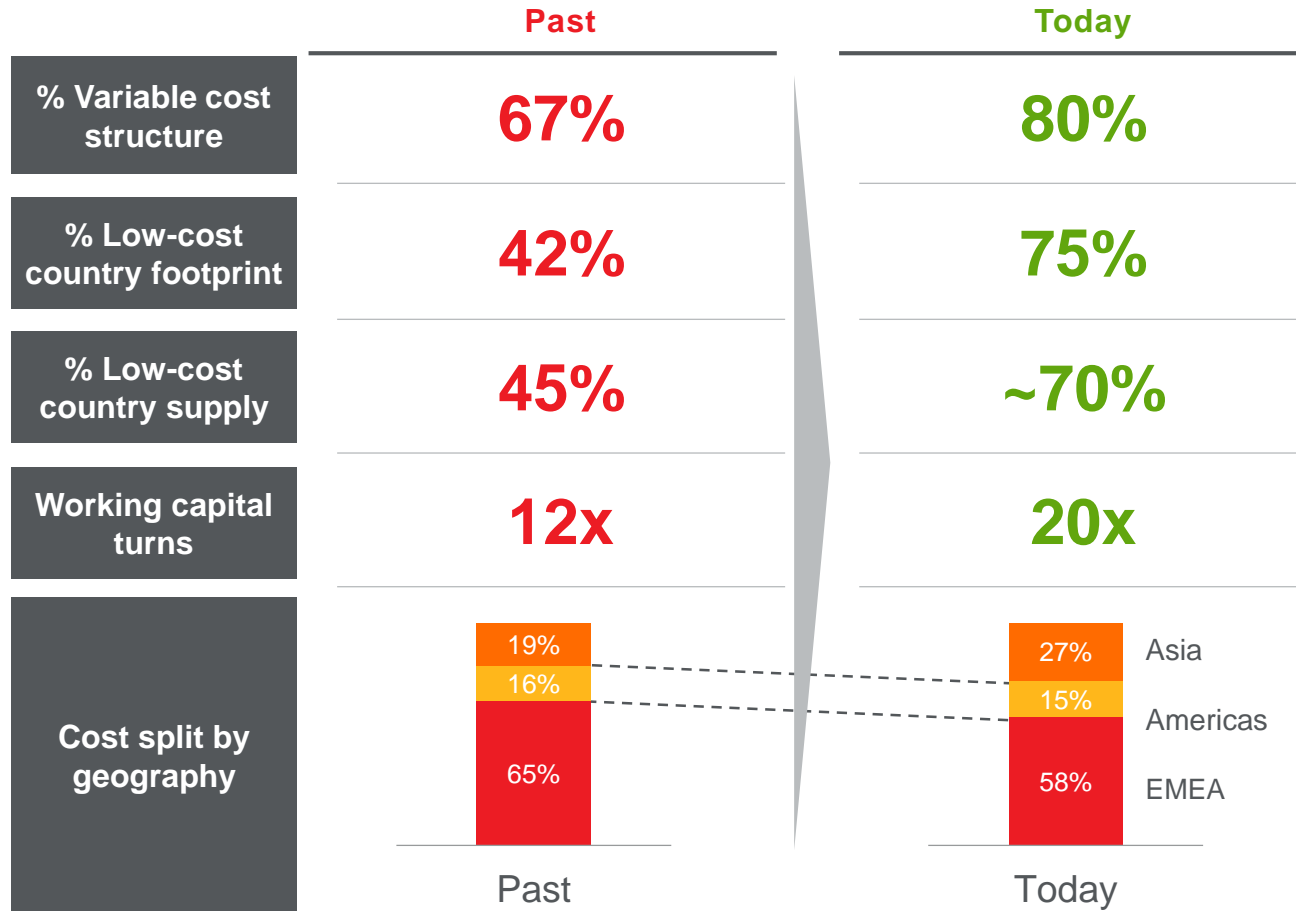

Takeaways

- Highly-variable cost structure to support the business through the cycle
- No large restructuring initiatives planned
- Low working capital needs
- Well-invested capacity base to support continued growth
- Honeywell Operating System drives operating excellence and embeds productivity in culture

5

Attractive financial profile

Operating costs breakdown

Operating costs

(\$mm, consistent with Form 10 figures)

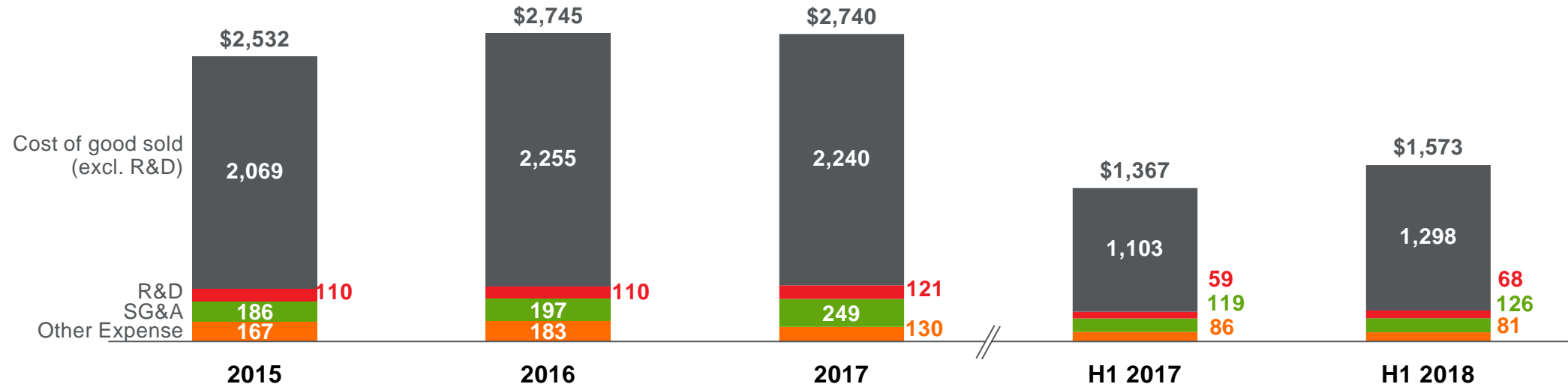

| | 2015 | 2016 | 2017 | H1 2017 | H1 2018 |
|-----------------------------------|------|------|------|---------|---------|
| Operating costs % of net revenues | 87% | 92% | 89% | 88% | 88% |
| Gross profit % | 25% | 21% | 24% | 25% | 24% |
| SG&A % of net revenues | 6% | 7% | 8% | 8% | 7% |
| R&D % of net revenues | 4% | 4% | 4% | 4% | 4% |

Note: Increase in SG&A in 2017 is primarily driven by higher corporate allocations from Honeywell

Copyrights © 2018 Garrett Motion Inc.

Consistent gross margin | ~82% of total operating costs in cost of goods sold

5

Attractive financial profile

Superior margin and cash flow metrics

2017 Consolidated EBITDA Margin¹

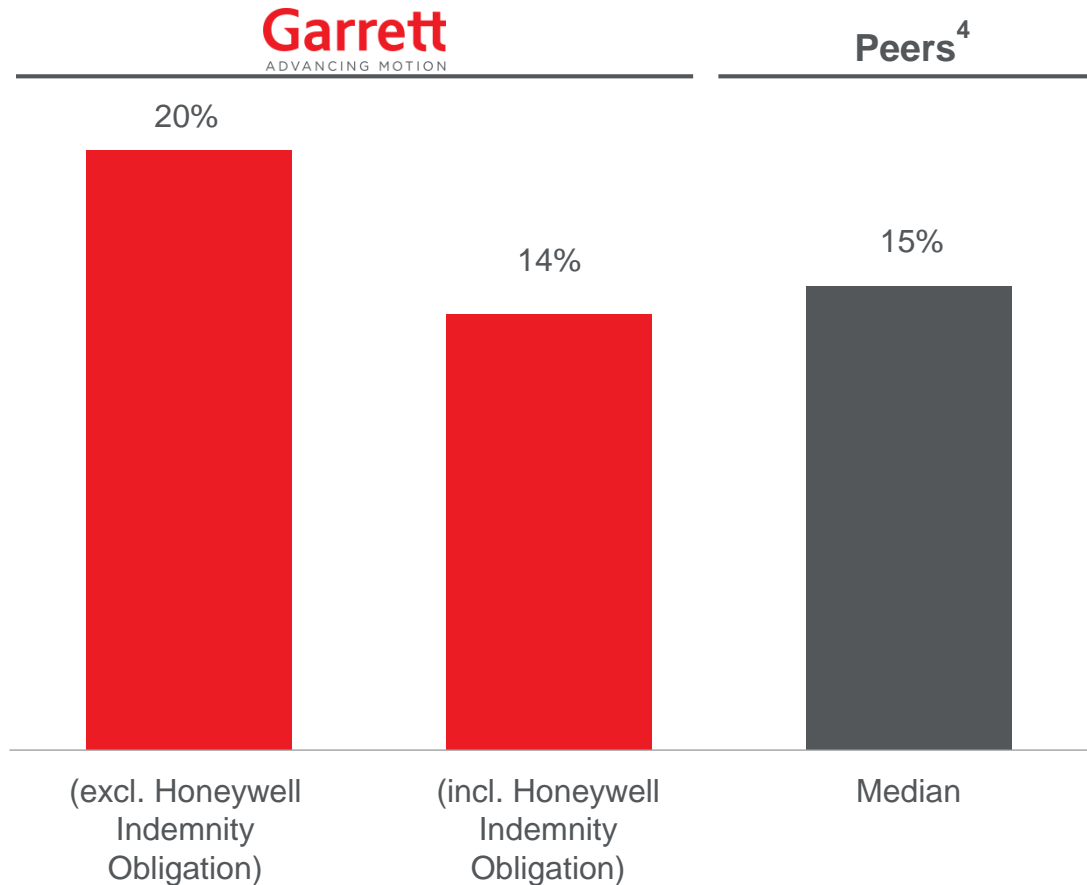

2017 Consolidated EBITDA less Adj. capital expenditures conversion^{1,2,3}

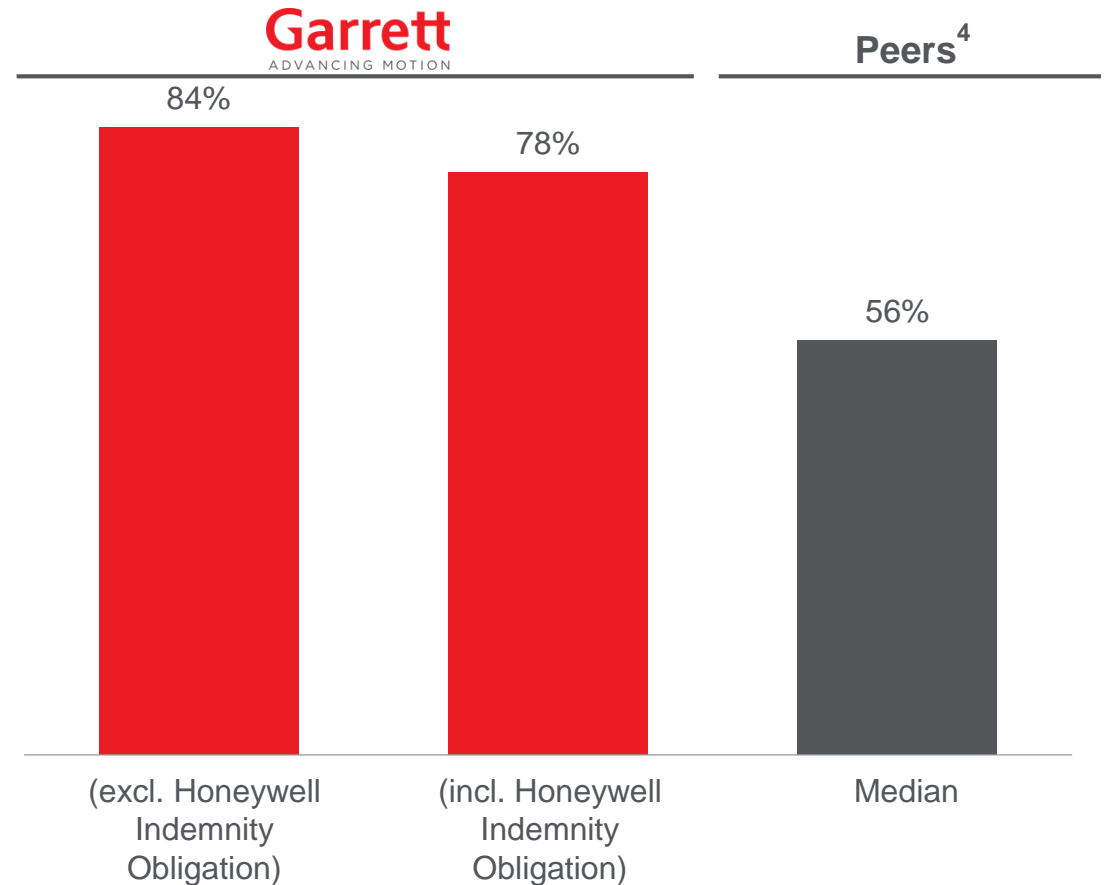

¹ Consolidated EBITDA is a Non-GAAP financial measure; please see the Appendix for a more detailed definition and a reconciliation to Net Income and Adjusted EBITDA as presented in the Form 10; ² Adj. capital expenditures is a Non-GAAP financial measure; please refer to the Appendix for its definition and a reconciliation to reported capital expenditures; ³ Defined as (Consolidated EBITDA – Adj. capital expenditures) / Consolidated EBITDA; please refer to the Appendix for a reconciliation; ⁴ Peers include BorgWarner, Delphi, Cummins, Continental, Denso, Valeo and Magna
 Source: Garrett Management; Public filings

5

Attractive financial profile

R&D and capital expenditure overview



R&D Priorities

- Strong portfolio of patents, applications and trademarks
- Ample research underway to support long-term product development
- Long lead times with OEM collaboration
- 30% of total engineering resources in China & India
- Stable outlook (% revenue)

Capital Expenditure Priorities

- Ample capacity and technology for growth
- No near-term need for additional plants
- Stable outlook (% revenue) for spending initiatives

Historical R&D Spending

(\$mm, consistent with Form 10 figures)

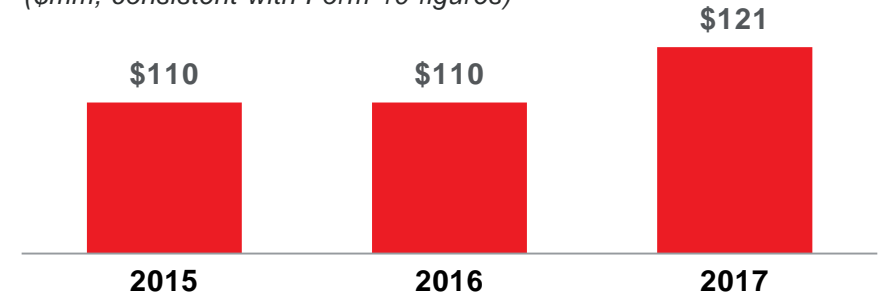

Historical Capital Expenditures

(\$mm, consistent with Form 10 figures)

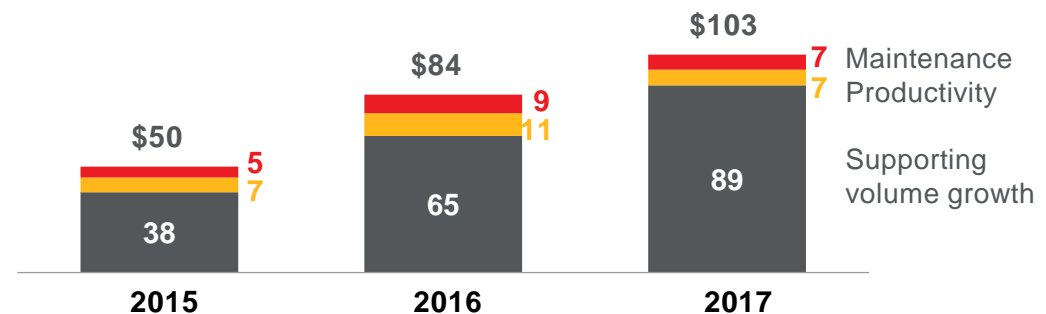

Copyrights © 2018 Garrett Motion Inc.

5

Attractive financial profile

Operating working capital breakdown

Operating working capital

(\$mm, consistent with Form 10 figures)

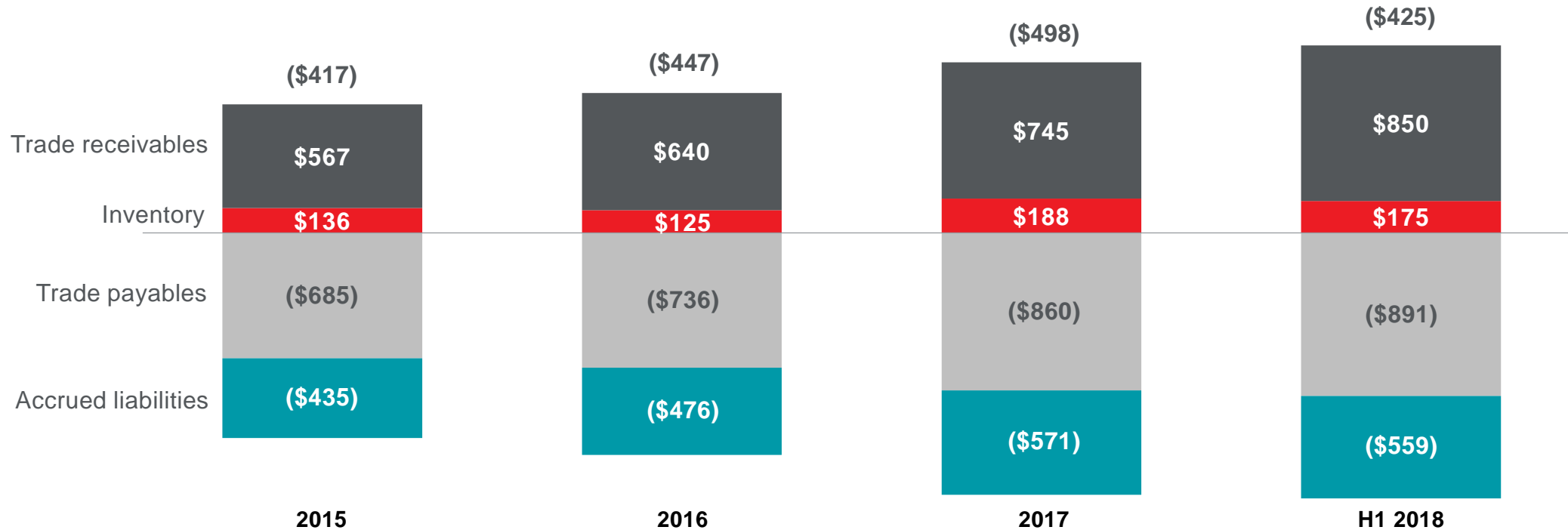

5

Attractive financial profile Balance sheet overview

Garrett balance sheet (Form 10)

| UNAUDITED PRO FORMA COMBINED BALANCE SHEET AS OF JUNE 30, 2018 (Dollars in millions) | | | |
|--|------------------------|--------------------------------------|-------------|
| | Historical As Reported | Pro Forma Adjustments ⁽¹⁾ | As Adjusted |
| ASSETS | | | |
| Current assets: | | | |
| Cash and cash equivalents | \$ 252 | \$ (162) | \$ 90 |
| Accounts, notes and other receivable—net | 850 | 7 | 857 |
| Inventories | 175 | — | 175 |
| Due from related parties, current | 11 | (11) | — |
| Other current assets | 48 | (31) | 17 |
| Total current assets | 1,336 | (197) | 1,139 |
| Investments and long-term receivables | 37 | — | 37 |
| Property, plant and equipment—net | 421 | — | 421 |
| Goodwill | 193 | — | 193 |
| Insurance recoveries for asbestos-related liabilities | 170 | (170) | — |
| Deferred income taxes | 41 | 181 | 222 |
| Other assets | 50 | 5 | 55 |
| Total assets | \$ 2,248 | \$ (181) | \$ 2,067 |
| LIABILITIES | | | |
| Current liabilities: | | | |
| Accounts payable | \$ 891 | \$ 87 | \$ 978 |
| Due to related parties, current | 197 | (197) | — |
| Accrued liabilities | 559 | (187) | 372 |
| Obligations payable to Honeywell, current | — | 209 | 209 |
| Total current liabilities | 1,647 | (88) | 1,559 |
| Long-term debt | — | 1,554 | 1,554 |
| Deferred income taxes | 723 | (709) | 14 |
| Asbestos-related liabilities | 1,516 | (1,512) | 4 |
| Other liabilities | 170 | 20 | 190 |
| Obligations payable to Honeywell | — | 1,572 | 1,572 |
| Total liabilities | 4,056 | 837 | 4,893 |
| COMMITMENTS AND CONTINGENCIES | | | |
| EQUITY (DEFICIT) | | | |
| Common Stock, par value \$0.001 | — | — | — |
| Additional paid in capital | — | (2,851) | (2,851) |
| Accumulated other comprehensive income | 9 | 16 | 25 |
| Invested deficit | (1,817) | 1,817 | — |
| Total deficit | (1,808) | (1,018) | (2,826) |
| Total liabilities and deficit | \$ 2,248 | \$ (181) | \$ 2,067 |

Obligations payable to Honeywell

| (in \$mm) | Total | Commentary |
|--------------------------------------|---------|--|
| Honeywell Indemnification Obligation | \$1,364 | <ul style="list-style-type: none"> Impact of Indemnification and Reimbursement Agreement with Honeywell Represents 90% of Honeywell's legacy Bendix asbestos liability; no actual transfer of liability to Garrett Garrett will make payments to Honeywell capped at \$175mm in respect of any year |
| Mandatory Transition Tax (MTT) | \$350 | <ul style="list-style-type: none"> Garrett's share of Honeywell's Mandatory Transition Tax related to US tax reform legislation Payable over 8 year period (same as other US corporates) One-time tax on non-previously taxed foreign earnings, that allows Garrett to immediately repatriate cash to the US tax free |
| Other | \$66 | <ul style="list-style-type: none"> Accounting rule related to legacy federal, state and local tax contingencies ~50% related to matters resolved (with no payment) since the 6/30/18 with the remainder unlikely to result in future cash payments |

Source: Publicly filed Form 10

Note: Figures may not exactly sum to totals due to rounding

Copyrights © 2018 Garrett Motion Inc.

5

Attractive financial profile

Honeywell Indemnification Obligation Agreement mechanics

Agreement Mechanics

- HON makes estimate at beginning of each year for annual payment
- Garrett pays $\frac{1}{4}$ of the annual estimate amount each quarter (30 days after Q end)
- True-up in Q1 of following year for any excess or deficiency payment (credit or debit for next year's amount)
- 30 year agreement; expires earlier if 3 consecutive years of <\$25mm paid
- Garrett meets quarterly with HON counsel to review case status and updates

Financial Framework for Equity Holders

- Indemnity payment similar to an annual "expense"
- HON hedges to Euro's-no FX risk to Garrett
- Subordinate to proposed Garrett credit agreement; covenants exactly align
- Rating agencies have factored into ratings
- Not more than \$175mm in respect of any one year, plus any accrued payment amounts
- Likely upside-amounts paid decrease over time
- Not a contingent liability

5

Attractive financial profile

Targeted capital structure

Sources and uses

| Sources (\$mm) | Amount | Uses (\$mm) | Amount |
|---|----------------|--|----------------|
| \$500mm Multi-Currency RC Facility (undrawn at close) | \$ - | Dividend to Honeywell | \$1,628 |
| New EUR Term Loan A | 400 | Financing fees, OID and other expenses | 32 |
| New Cross-Border Term Loan B ² | 750 | | |
| New EUR Sr. Notes | 510 | | |
| Total Sources | \$1,660 | Total Uses | \$1,660 |

Pro forma capitalization

| (\$mm) | PF 6/30/2018 | xLTM 6/30/18 Consolidated EBITDA ³ |
|---|----------------|---|
| Cash ¹ | \$90 | |
| \$500mm Multi-Currency RC Facility (undrawn at close) | - | |
| New EUR Term Loan A | 400 | |
| New Cross-Border Term Loan B ² | 750 | |
| Secured debt | \$1,150 | ~2.25x |
| New EUR Sr. Notes | 510 | |
| Total debt | \$1,660 | ~3.25x |
| LTM 6/30/18 Consolidated EBITDA³ | | \$513 |

Note: All tranche sizes quoted in USD-equivalent

¹ Cash on balance sheet at close will be legacy Garrett cash left behind for working capital purposes

² Subject to minimum tranche size of \$300mm

³ Consolidated EBITDA is a Non-GAAP financial measure and is calculated as defined in our proposed Credit Agreement, which includes impact of Honeywell Indemnity Obligation and certain other adjustments; please see the Appendix for a more detailed definition and a reconciliation to Net Income and Adjusted EBITDA as presented in the Form 10

Copyrights © 2018 Garrett Motion Inc.

5

Attractive financial profile

Financial goals through 2022

| | |
|---|--|
| Revenue growth targets | 4–6% CAGR |
| Consolidated EBITDA¹ margin excluding I/O Payment | 18–20% (excluding impact of Honeywell Indemnity Obligation payment) |
| Adj. capital expenditures² | 3–3.5% of sales |
| Tax rate | ~27%, improving through 2022 |
| Liquidity | Maintain strong liquidity position – targeting \$500mm Revolving Credit Facility |
| Target leverage | Targeting long-term gross leverage of ~2x |
| Dividends, buybacks, deleveraging | Deleveraging as primary focus; cash dividends and share repurchases considered subject to review and approval of the Garrett Board of Directors |

Note: Achieving these stated financial goals involves risks and uncertainties; many factors could affect actual financial results and could cause actual results to differ materially from these stated financial goals. See “Forward Looking Statements.”

¹ Consolidated EBITDA is a Non-GAAP financial measure; please refer to Appendix for its definition and a reconciliation to Net Income and Adjusted EBITDA as presented in the Form 10

² Adj. capital expenditures is a Non-GAAP financial measure; please refer to the Appendix for its definition and a reconciliation to reported capital expenditures

Copyrights © 2018 Garrett Motion Inc.

Conclusions & Key Takeaways

Olivier Rabiller - CEO



Extending growth into new technology domains

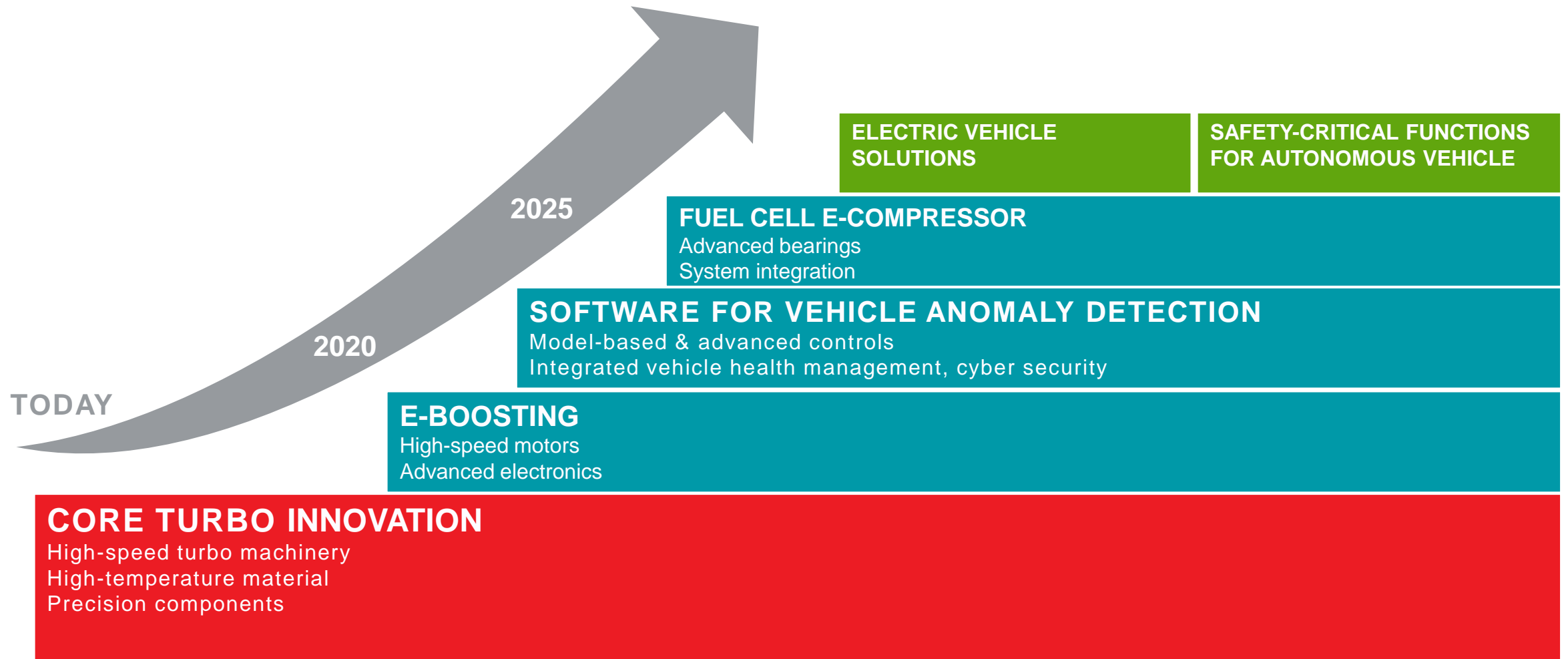

Key Garrett priorities



**GLOBAL MARKET LEADERSHIP
WITH ACCELERATING MACRO
TAILWINDS**

- Be supplier of choice for all global engine platforms
- Leverage our strong position in high growth regions to overdrive local macros growth
- Keep optimizing our geographic and channel coverage in aftermarket



**TECHNOLOGY LEADERSHIP WITH
BROAD PORTFOLIO OF PRODUCTS
WITH BREAKTHROUGH
CAPABILITIES**

- Provide leading solutions for increasing demand across all powertrain platforms
- Extend our differentiated technology platforms to E-Boosting, Cyber Security, and Integrated Vehicle Health Management



**LONG-TERM CO-DEVELOPMENT
WITH GLOBAL OEMS WORLDWIDE
AFTERMARKET PLATFORM**

- Maintain strong customer intimacy with early engagement; including new growth vectors
- Leverage local emerging technology trends
- Keep expanding aftermarket products and service



**BEST-IN-CLASS GLOBAL
MANUFACTURING FOOTPRINT
WITH OPERATIONAL
EXCELLENCE AND AGILITY**

- Further evolve HOS; drive to the lowest cost
- Keep developing advanced manufacturing technology both in-house and at suppliers
- Further optimize supply chain and working capital performance



ATTRACTIVE FINANCIAL PROFILE

- Use strong cash flow generation to deleverage the company
- Keep improving financial performance in all key metrics

Appendix

Garrett
ADVANCING MOTION

Internal Combustion Engines (ICE) & Hybrids are the most cost competitive powertrain

BEV: \$9.3K, 0g/mi CO₂

Motor: \$1000 T/M: \$150 Electronics: \$2200 Battery Pack: \$6K



ICE: \$2.1K, 380 mile range, 220 g/mi CO₂

Engine: \$1000 T/M: \$350 Electronics: \$150 Exhaust: \$500 Fuel Tank: \$80

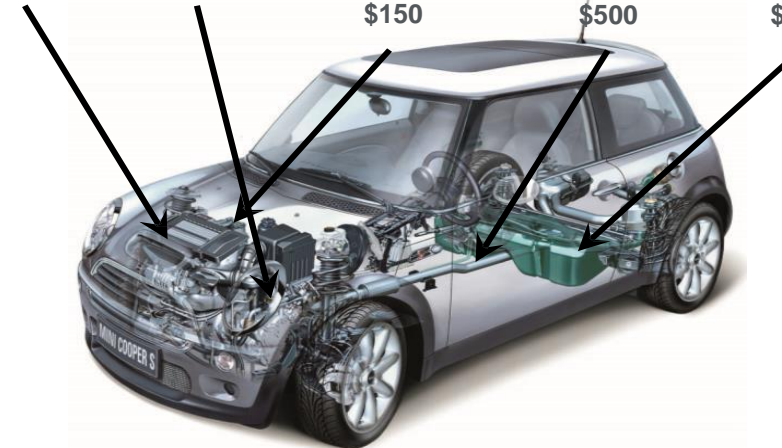

| Powertrain Cost | BEV (2016) | BEV (2025) | PHEV (2016) | PHEV (2025) | ICE (gas) |
|---------------------|----------------|-----------------|----------------|----------------|----------------|
| Battery Pack | \$6,000 | \$11,000 | \$2,000 | \$1,300 | \$0 |
| Electric Range (mi) | 80 miles | 300 miles | 30 miles | 30 miles | - |
| IC Engine | \$0 | \$0 | \$600 | \$1,000 | \$1,000 |
| Electric Motor | \$1,000 | \$900 | \$600 | \$540 | \$0 |
| Others | \$2,350 | \$1,900 | \$2,200 | \$1,900 | \$1,100 |
| Total Cost | \$9,300 | \$13,800 | \$5,400 | \$4,740 | \$2,100 |

Source: UBS "Evidence Lab Electric Car Teardown" May 2017; Garrett data

Copyrights © 2018 Garrett Motion Inc.

BEV: "Zero" emission but 3x to 6x cost of hybrid or pure ICE, limited range

Summary of Honeywell Indemnification Obligation

What is the background?

- Honeywell is transferring responsibility to Garrett for certain Transportation Systems liabilities in connection with the separation
- The liabilities are comprised of asbestos liabilities, predominately Bendix, as well as some environmental liabilities
- Bendix Corporation dates back to 1920s and historically sold brake pads that contained asbestos
- Honeywell acquired Bendix through its merger with Allied Signal in 1999 and it became part of the TS business
- Honeywell sold Bendix assets to Federal Mogul in 2014 and retained asbestos liabilities / claims
- Today, Honeywell is a defendant in asbestos personal injury actions mainly related to legacy Bendix Friction Materials business

Why create an Indemnity Agreement?

- Garrett has entered into an indemnification agreement with Honeywell as a means to create an obligation for Garrett to pay annually while not transferring the actual legal obligation for the liability
 - Honeywell will retain legal obligation related to liability and continue to manage claims and administrative processes
 - In a given year, Garrett will not be responsible for more than \$175mm payment, plus any accrued payment amounts in respect of any year, related to the indemnification agreement
 - Structure removes uncertainty for Garrett (i.e., payment cannot exceed cap plus accrued amounts), subordinates agreement to Garrett's senior debt, and means Garrett can benefit from Honeywell's administration infrastructure already in place
- Honeywell will continue to be responsible for 10% of the Bendix payment and will therefore have incentives aligned with Garrett to minimize annual payments and effectively manage the settlement of claims as they have done historically

Honeywell indemnity obligation liability overview

Overview of Honeywell Indemnity Obligation liability and accounting treatment

| | |
|--|---|
| Honeywell Indemnity Obligation overview | <ul style="list-style-type: none">▪ Bendix Corporation dates back to the 1920s and historically sold brake pads that contained asbestos▪ Honeywell acquired Bendix through its merger with Allied Signal in 1999▪ Honeywell sold Bendix assets to Federal Mogul in 2014 and retained asbestos liabilities / claims▪ Today, Honeywell is a defendant in asbestos personal injury actions mainly related to its legacy Bendix business |
| Balance sheet | <ul style="list-style-type: none">▪ Upon spin, Garrett recognizes a liability to account for the contingent aspect of the indemnification and carries over Honeywell's historical basis of the underlying obligation being indemnified (ASC 450, loss contingency is probable and reasonably estimable)▪ As of June 30, 2018, the Company would have approximately \$1,364mm of liability under the Indemnification and Reimbursement Agreement▪ Based on the Indemnification Agreement, the liability will generally be recorded at 90% of Honeywell's accrued liability for legacy Automotive Honeywell Indemnity Obligation Asbestos (net of insurance receivables) and Environmental accrual (net of insurance and certain other recoveries)▪ Quarterly meetings between Honeywell counsel managing liability and Garrett counsel to discuss claims experience |
| Income statement | <ul style="list-style-type: none">▪ Garrett will generally record 90% of the Bendix asbestos claims and legal fees, less anticipated insurance receivables, and legacy environmental costs, less those recoveries described above, recorded by Honeywell, and adjusted for any payments not expected to be made because they exceed the \$175mm cap |
| Statement of cash flow | <ul style="list-style-type: none">▪ Garrett will record an operating cash outflow for amounts paid to Honeywell in respect of a given year not to exceed the \$175mm cap plus any payment amounts, accruing if Garrett is subject to a specified event of default under certain indebtedness or is not compliant with certain financial covenants in certain indebtedness on a pro forma basis, provided these conditions are not continuing at this time of payment |
| Tax treatment | <ul style="list-style-type: none">▪ Garrett's indemnity payments to Honeywell will not be tax deductible by Garrett |

Consolidated EBITDA Walk: 2015 – 2016

(\$mm)

% of Net revenues
11.1%

17.2%

17.6%

11.7%

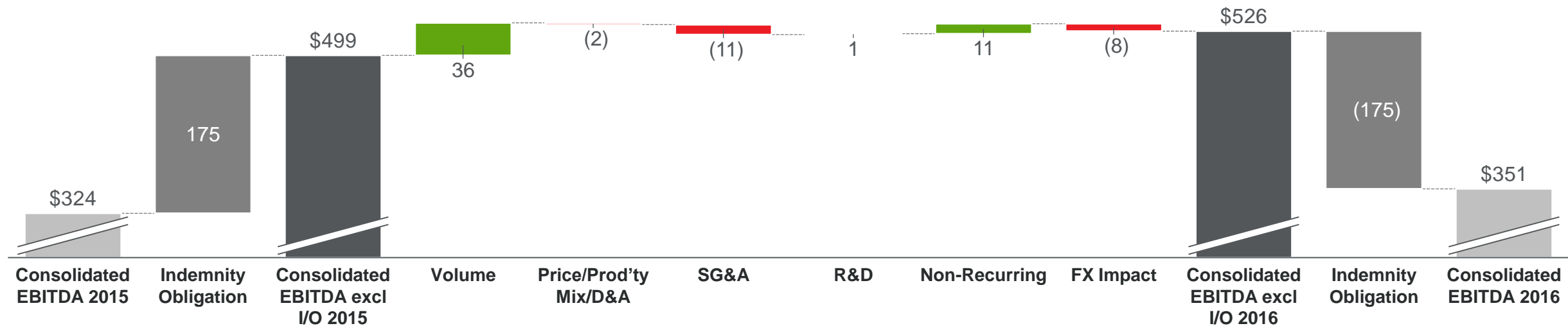

Note: Consolidated EBITDA is a Non-GAAP financial measure; please refer to the Appendix for its definition and a reconciliation to Net Income and Adjusted EBITDA as presented in the Form 10 Copyrights © 2018 Garrett Motion Inc.

2016 Consolidated EBITDA growth mostly driven by volume

Consolidated EBITDA Walk: 2016 – 2017

(\$mm)

% of Net revenues
11.7%

17.6%

20.1%

14.5%

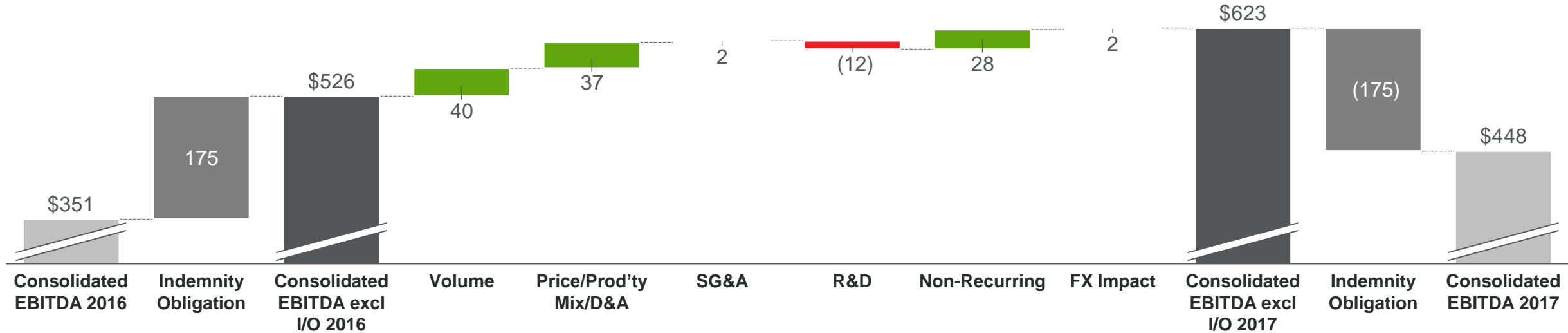

Note: Consolidated EBITDA is a Non-GAAP financial measure; please refer to the Appendix for its definition and a reconciliation to Net Income and Adjusted EBITDA as presented in the Form 10 Copyrights © 2018 Garrett Motion Inc.

Solid consolidated EBITDA growth

Consolidated EBITDA Walk: H1 2017 – H1 2018

(\$mm)

% of Net revenues
14.2%

19.8%

20.7%

15.8%

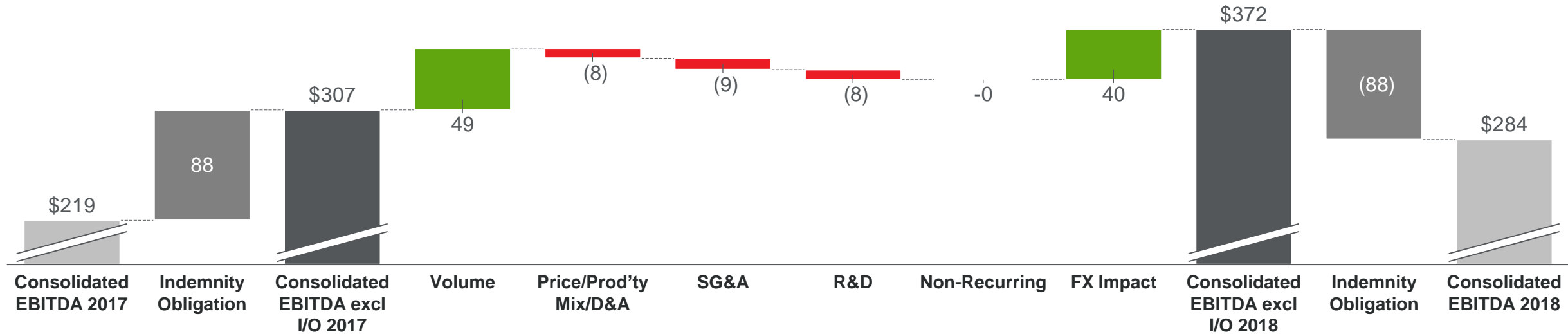

Note: Consolidated EBITDA is a Non-GAAP financial measure; please refer to the Appendix for its definition and a reconciliation to Net Income and Adjusted EBITDA as presented in the Form 10 Copyrights © 2018 Garrett Motion Inc.

21% Consolidated EBITDA growth excl. Indemnity Obligation and including FX impact

Consolidated EBITDA reconciliation

Consolidated EBITDA reconciliation

| \$mm | 2015 | 2016 | 2017 | LTM 6/30/18 ¹ | 1H 2017 | 1H 2018 |
|--|--------------|--------------|--------------|-----------------------------|--------------|--------------|
| Net income (loss) (GAAP) | \$254 | \$199 | (\$983) | (\$955) | \$180 | \$208 |
| Plus: income taxes | 114 | 51 | 1,349 | 1,353 | 8 | 12 |
| Plus: Net interest expense (income) | (8) | (9) | (6) | (5) | (4) | (3) |
| Plus: Depreciation & Amortization | 64 | 59 | 64 | 70 | 30 | 36 |
| EBITDA (Non-GAAP) | \$424 | \$300 | \$424 | \$463 | \$214 | \$253 |
| Other operating expenses, net (asbestos and environmental expenses) | 167 | 183 | 130 | 125 | 86 | 81 |
| Stock compensation expense | 10 | 12 | 15 | 19 | 8 | 12 |
| Repositioning charges | 3 | 46 | 20 | 13 | 9 | 2 |
| Non-operating (income) expense | 10 | 3 | 1 | (3) | - | (4) |
| Adjusted EBITDA (Non-GAAP) included in Form 10 | \$614 | \$544 | \$590 | \$617 | \$317 | \$344 |
| ① Honeywell Indemnity Obligation payment | (175) | (175) | (175) | (175) | (88) | (88) |
| ② FX Hedging (gain) / loss (net) | (68) | 18 | (14) | 30 | (16) | 28 |
| ③ Estimated standalone costs | (45) | (45) | 9 | 7 | 1 | (1) |
| ④ U.S. GAAP Change – Revenue Recognition | 8 | 9 | 10 | 5 | 5 | - |
| ⑤ Other nonrecurring, non-cash expense | (10) | - | 28 | 29 | - | 1 |
| Consolidated EBITDA (Non-GAAP) | \$324 | \$351 | \$448 | \$513 | \$219 | \$284 |
| Add: Honeywell Indemnity Obligation payment | 175 | 175 | 175 | 175 | 88 | 88 |
| Consolidated EBITDA (Non-GAAP, excl. Honeywell indemnity obligation) | \$499 | \$526 | \$623 | \$688 | \$307 | \$372 |
| Consolidated EBITDA % margin (Non-GAAP, excl. Honeywell indemnity obligation) | 17% | 18% | 20% | 21% | 20% | 21% |

Commentary

- ① Inclusion of \$175mm Honeywell Indemnity Obligation payment
- ② Removal of FX hedging-related gains and losses and unrealized FX re-measurement gains included in EBITDA
- ③ Incremental costs above corporate allocations already included in Adjusted EBITDA based on standalone cost assessment
- ④ Represents the impact of the retrospective application of U.S. GAAP change for Revenue Recognition (ASC 606) adopted by the Company beginning in 2018, where upfront payments to customers are deferred and expensed over the estimated life of the customer contract
- ⑤ Other adjustments consists of non-recurring, non-cash charges primarily related to incremental freight costs incurred as a result of transferring production across various European plants, non-US tax credits and bad debt expense

Note: Consolidated EBITDA is calculated in accordance with our proposed Credit Agreement and differs from EBITDA and Adjusted EBITDA as presented in the Form 10; We define "Consolidated EBITDA", which is a Non-GAAP financial measure, as Adjusted EBITDA less the assumed cash paid for asbestos and environmental obligations subject to a cap (denominated in Euro) equal to \$175mm, calculated by reference to the Distribution Date Currency Exchange Rate in respect of a year in accordance with the terms of the Indemnification and Reimbursement Agreement, plus the sum of hedging (gains) losses, the difference between our estimate of costs as a stand-alone company and historical allocated costs, the impact of the cumulative effect of the change in accounting principles, and one-time non-cash charges. Consolidated EBITDA is used as part of our calculations with respect to compliance with certain debt covenants included in our proposed credit agreement

¹ Represents last 12 months as of 6/30/2018

Calculation of Consolidated EBITDA Margin and Consolidated EBITDA less Adj. Capital Expenditures conversion

| | <i>Constant currency</i> | | | | | |
|---|---------------------------------|---------------------------------|---------------------------------|--------------------------------------|--------------------------------------|--------------------------------------|
| | 6 months ended June 30, 2018 | 6 months ended June 30, 2018 | 6 months ended June 30, 2017 | 12 months ended December 31, 2017 | 12 months ended December 31, 2016 | 12 months ended December 31, 2015 |
| <i>(\$mm)</i> | | | | | | |
| Consolidated EBITDA (Non-GAAP) | \$284 | \$244 | \$219 | \$448 | \$351 | \$324 |
| ÷ Net sales | \$1,792 | \$1,659 | \$1,547 | \$3,096 | \$2,997 | \$2,908 |
| Consolidated EBITDA margin (Non-GAAP) | 16% | 15% | 14% | 14% | 12% | 11% |
| Consolidated EBITDA excl. I/O payment (Non-GAAP) | \$372 | \$332 | \$307 | \$623 | \$526 | \$499 |
| <i>Organic growth (%)</i> | | 8% | | | | |
| ÷ Net sales | \$1,792 | \$1,659 | \$1,547 | \$3,096 | \$2,997 | \$2,908 |
| Consolidated EBITDA margin (Non-GAAP) | 21% | 20% | 20% | 20% | 18% | 17% |
| Consolidated EBITDA (Non-GAAP) | \$284 | \$244 | \$219 | \$448 | \$351 | \$324 |
| Adj. capital expenditures (Non-GAAP) | (\$33) | (\$33) | (\$24) | (\$97) | (\$91) | (\$77) |
| Consolidated EBITDA less Adj. capital expenditures (Non-GAAP) | \$251 | \$211 | \$195 | \$351 | \$260 | \$247 |
| ÷ Consolidated EBITDA (Non-GAAP) | 88% | 86% | 89% | 78% | 74% | 76% |
| Consolidated EBITDA excl. I/O payment (Non-GAAP) | \$372 | \$332 | \$307 | \$623 | \$526 | \$499 |
| Adj. capital expenditures (Non-GAAP) | (\$33) | (\$33) | (\$24) | (\$97) | (\$91) | (\$77) |
| Consolidated EBITDA excl. I/O payment less Adj. capital expenditures (Non-GAAP) | \$339 | \$299 | \$283 | \$526 | \$435 | \$422 |
| ÷ Consolidated EBITDA excl. I/O payment (Non-GAAP) | 91% | 90% | 92% | 84% | 83% | 85% |
| Net income (loss) (GAAP) | \$208 | | \$180 | (\$983) | \$199 | \$254 |
| ÷ Net sales | \$1,792 | | \$1,547 | \$3,096 | \$2,997 | \$2,908 |
| Net income (loss) margin | 12% | | 12% | (32%) | 7% | 9% |

Note: Consolidated EBITDA is a Non-GAAP financial measure; please refer to the Appendix for its definition and a reconciliation to Net Income and Adjusted EBITDA as presented in the Form 10; Adj. capital expenditures is a Non-GAAP financial measure; please refer to the Appendix for its definition and a reconciliation to reported capital expenditures

We believe that Consolidated EBITDA less cash expenditures for property, plant and equipment is useful to investors and management as a measure of cash generated by business operations that will be used to repay scheduled debt maturities and can be used to invest in future growth through new business development activities or acquisitions, pay dividends, repurchase stock or repay debt obligations prior to their maturities. This metric can also be used to evaluate our ability to generate cash flow from business operations and the impact that this cash flow has on our liquidity.

Copyrights © 2018 Garrett Motion Inc.

Adj. Capital Expenditures reconciliation

Adj. capital expenditures reconciliation

Commentary

| <i>\$mm</i> | 2015 | 2016 | 2017 | LTM 6/30/18 ¹ | 1H 2017 | 1H 2018 | |
|--|-------------|-------------|--------------|-----------------------------|-------------|-------------|---|
| Total Capital Expenditures (included in Form 10) | \$50 | \$84 | \$103 | \$116 | \$34 | \$47 | 1 Relates to Garrett Property, Plant & Equipment |
| 1 Adjustments and changes in PPE related Accounts Payable | - | (4) | (6) | (6) | (13) | (13) | 2 } Supplemental reconciled items to be reflected as cash adjustment |
| 2 Transfer in / out | 3 | 3 | 6 | 2 | 5 | 1 | |
| 3 Total transfers from Construction in Process | (1) | 2 | (3) | 0 | (5) | (2) | 4 Large 2015 activity relates to upfront tooling contributions |
| 4 Other | 25 | 6 | (3) | (6) | 3 | 0 | |
| Total Garrett adjusted capital expenditures (Non-GAAP) | \$77 | \$91 | \$97 | \$106 | \$24 | \$33 | |
| <i>% of revenue</i> | 2.6% | 3.0% | 3.1% | 3.2% | 1.6% | 1.8% | |

¹ Represents last 12 months as of 6/30/2018

Reconciliation of Organic Sales % change

| | 6 months ended June 30, 2018 | 12 months ended December 31, 2017 | 12 months ended December 31, 2016 |
|--|---------------------------------|--------------------------------------|--------------------------------------|
| Garrett | | | |
| Reported sales % change | 16% | 3% | 3% |
| Less: Foreign currency translation | (9%) | (1%) | 0% |
| Organic sales % change (Non-GAAP) | 7% | 3% | 3% |
| Gasoline | | | |
| Reported sales % change | 39% | 7% | 23% |
| Less: Foreign currency translation | (11%) | (0%) | (1%) |
| Organic sales % change (Non-GAAP) | 28% | 6% | 23% |
| Diesel | | | |
| Reported sales % change | 8% | (7%) | (1%) |
| Less: Foreign currency translation | (10%) | (1%) | 0% |
| Organic sales % change (Non-GAAP) | (2%) | (8%) | (1%) |
| Commercial vehicles and new initiatives | | | |
| Reported sales % change | 12% | 16% | (1%) |
| Less: Foreign currency translation | (6%) | (0%) | 0% |
| Organic sales % change (Non-GAAP) | 6% | 16% | (1%) |

Note: We define organic sales percent as the year-over-year change in reported sales relative to the comparable period, excluding the impact on sales from foreign currency translation, acquisitions, net of divestitures and non-comparable impacts from adoption of the new revenue recognition standard. We believe this measure is useful to investors and management in understanding our ongoing operations and in analysis of ongoing operating trends. We define organic sales as revenue at constant currency foreign exchange rates; Figures may not exactly sum to totals due to rounding

Garrett
ADVANCING MOTION